



SAFE-T-BEAM® SYSTEM INSTALLATION INSTRUCTION

1 IMPORTANT INFORMATION

⚠ WARNING



Moving Door can cause serious injury or death.

- Wall control must be mounted in sight of garage door, at least 5 feet above floor and clear of moving parts.
- Keep people clear of opening while door is moving.
- **Do Not** allow children to play with remote or door opener.

If Safety Reverse does not work properly:

- **Close door, then disconnect opener** using manual release handle.
- **Do Not** use remote or door opener.
- Refer to Door and Door Opener Owner's Manuals before attempting any repairs.



Electrical Shock can cause serious injury or death.

- Power cord must be unplugged before attaching any wires.
- Be sure wire ends do not touch each other or other terminals.

If you have questions or if you need a manual, contact the distributor or manufacturer of the opener.

2 MOUNTING SOURCE & SENSOR

Locations of existing units can be reused if that is desired. Safe-T-Beam® System (STB) Source and Sensor do not have to be mounted on garage door frame. They can be placed anywhere along garage door wall that is convenient for mounting, provided the location meets the following requirements:

- 1) They must be placed across the door opening,
- 2) at proper height,
- 3) with a clear line of sight between them. (Max. Range is 30 feet).
(They may be mounted on floor, only as a last resort, if there is no other option. Not recommended.)

1. To ease mounting, source and sensor units can be detached from the bracket by pulling them apart. After mounting brackets, slide units back onto brackets.

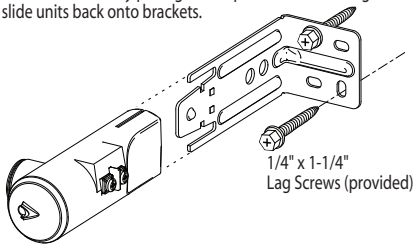

1/4" x 1-1/4"
Lag Screws (provided)

2. Ensure there will be an unobstructed path between source and sensor. Sensor should be mounted on the side of the garage door opening that receives the least direct sunlight.

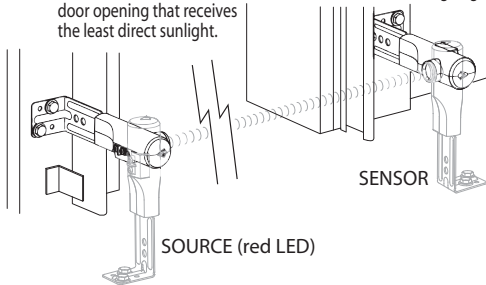

SENSOR

SOURCE (red LED)

3. Once location is established, measure height of bracket as shown. Hold bracket in place and mark hole locations. 1/8" pilot holes are recommended.

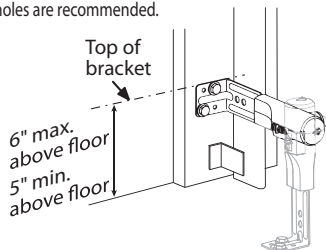

No height adjustment is needed for units mounted on floor.

3 WIRE RUN

Reuse of existing wiring is easiest and recommended unless it is broken, cut, frayed or there is a problem. If you can reuse existing wiring — SKIP FORWARD TO STEP 4. If new wiring must be installed, the path shown below is recommended.

Need to install new wire? Wire and Wire Clips (for fastening the wire to the rail) can be purchased through Customer Service at 800-275-6187 or at a local Factory Authorized Overhead Door Dealer using the information at the end of this instruction. The path shown below is recommended for routing the wire run.

1. Route two (2) lengths of two (2) conductor wire (See above) from opener, along top of rail.

Fasten wire to rail.
— Evenly space fasteners along rail.

Fasten to header and wall (preferably with insulated staples). Allow for some slack at the source and sensor units and cut off any excess wire.

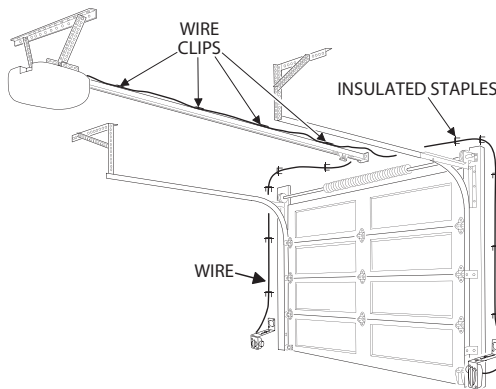

⚠ CAUTION:

When using insulated staples, be aware that staples which are too tight can cut or pinch wires. Cut or pinched wires can cause the Safe-T-Beam® System to stop working. When using insulated staples, make sure you fasten them only as tightly as needed to hold the wire snugly.

2. At source and sensor, route wires through bracket as shown and attach wires at terminals. Either wire to either terminal (non-polar).

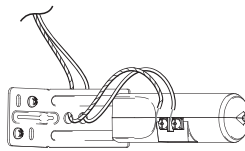

NO POLARITY
EITHER WIRE TO EITHER TERMINAL IS OKAY

3. If installing new wiring:
At opener, twist striped wires together. Twist plain wires together. Feed down through control wire tube "chimney" at top of opener.

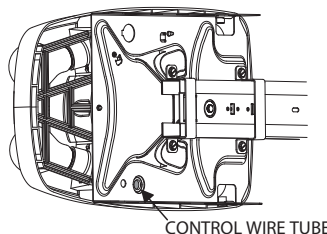

CONTROL WIRE TUBE

4. Attach to terminals #1 and #2 (again either wire). Bundle excess wire and tape to top of power head.

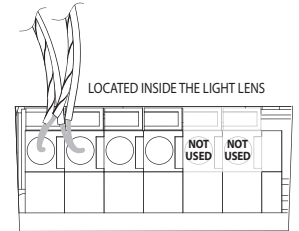

LOCATED INSIDE THE LIGHT LENS

AT OPENER

- 1 STB
- 2 BWC
- 3
- 4
- 5 IWC
- 6

4 SAFE-T-BEAM® SYSTEM TEST

Safe-T-Beam® System must be installed and working properly in order for door opener to function.

⚠ CAUTION:

During testing of the Safe-T-Beam® System, be sure to stay clear of the door and any moving parts. It is preferable to use a long-handled object to interrupt the beam during tests.

1. Start door moving in close direction.
2. Pass an object through the path of the Safe-T-Beam® System in order to interrupt beam.
— Door should stop and reverse direction to fully open position.

If door will not run in closed direction, check for:

- Misalignment of Safe-T-Beam® System (Red LED on source unit will be blinking).
- Obstruction in path of beam.
- Pinched or broken wire.
- Loose wiring connection.

If you still have a problem, contact Customer Service at 800-275-6187.

NOTE: If the situation demands that the door be closed, this can be done by pressing and holding the wall button or wall console button until the door is fully closed.

⚠ WARNING:

As the door is closing, constantly observe the door opening to prevent anyone moving into the path of the door.
If this happens, immediately release button.

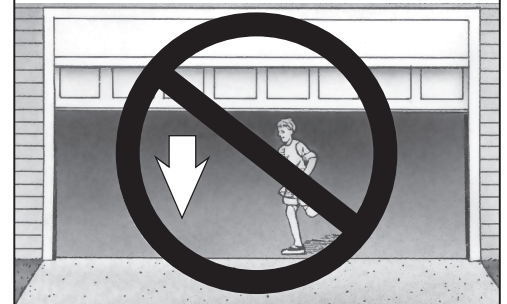

For answers to any questions, problems or concerns, please contact Customer Service at 800-275-6187.

To order wire or wire clips use following part numbers:

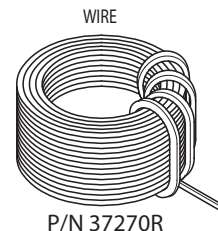

P/N 37270R



P/N 37125A

