

The Genuine. The Original.

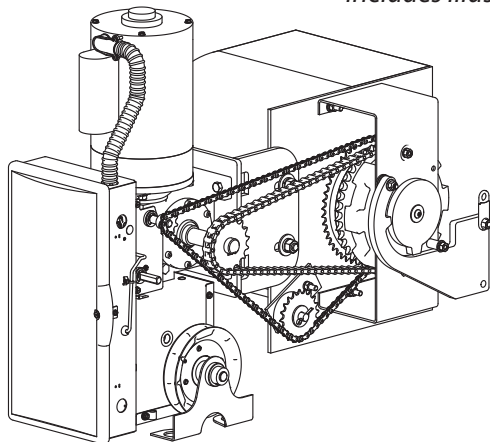


112166.502351 04-14

# FireKing<sup>®</sup> Heavy Duty Operator

## FIRE DOOR APPLICATION

*Includes illustration for connection to a fire door release system.*



WITH EXCLUSIVE FEATURES:

**Voltamatic<sup>®</sup>**

**Limit Lock<sup>®</sup>**

### PROPER APPLICATION

Door Type	Operator Type	HP/Max Door Weight
Rolling Steel (non-tension release fire door)	Hoist (Front of Hood Mount)	1/2HP = 1310 lbs. 1HP = 1650 lbs. 3HP = 3696 lbs.

\*Door weights for Rolling Steel Doors are based on sprocket selection derived from the configurator guidelines.

## NOT FOR RESIDENTIAL USE

**This Installation Manual provides the information required to install, troubleshoot and maintain a FireKing<sup>®</sup> Commercial/Industrial Door Operator.**

THIS PAGE LEFT BLANK

# Table of Contents

<b>Section 1</b>	<b>How to use this manual</b> . . . . .	<b>1.1</b>	<b>Section 7</b>	<b>Special Operational Features</b> . . . . .	<b>7.1-7.2</b>
<b>Section 2</b>	<b>Safety Information &amp; Instructions</b> . . . . .	<b>2.1-2.2</b>		Operator Cycle Count . . . . .	7.1
<b>Section 3</b>	<b>Critical Installation Information</b> . . . . .	<b>3.1-3.4</b>		GDO & Display Firmware . . . . .	7.1
<b>Section 4</b>	<b>Installation</b> . . . . .	<b>4.1-4.8</b>		Operator Type . . . . .	7.2
	Mounting Operator . . . . .	4.1	<b>Section 8</b>	<b>Troubleshooting</b> . . . . .	<b>8.1-8.5</b>
	Right Hand Install . . . . .	4.2		Display Operation . . . . .	8.1
	Left Hand Install . . . . .	4.3		Error Codes . . . . .	8.1-8.2
	Limit Chain and Drive Chain . . . . .	4.4-4.5		Run Codes . . . . .	8.2-8.3
	Hand Chain . . . . .	4.6		LED Indicators . . . . .	8.4
	Optional Fire Door Release System (Through Wall) . . . . .	4.7		Safe-T-Beam® Self-Diagnostic Troubleshooting Chart . . . . .	8.5
	Optional Fire Door Release System (No Through Wall) . . . . .	4.8	<b>Section 9</b>	<b>Service &amp; Maintenance</b> . . . . .	<b>9.1</b>
<b>Section 5</b>	<b>Wiring</b> . . . . .	<b>5.1-5.13</b>		Periodic Maintenance Schedule . . . . .	9.1
	Safety Information/ Line Voltage Wiring . . . . .	5.1-5.2	<b>Section 10</b>	<b>Appendices</b> . . . . .	<b>10.1-10.11</b>
	Low Voltage Control Wiring . . . . .	5.3		Appendix A . . . . .	10.1-10.7
	External Wire Diagram . . . . .	5.4		Basic Operator Repair Parts . . . . .	10.1-10.2
	Wall Control . . . . .	5.5		Basic Hoist Shafts Repair Parts . . . . .	10.3
	Interlock Switches . . . . .	5.6		Basic Brake/Release Repair Parts . . . . .	10.4
	Monitored Photocell Device Wiring . . . . .	5.7		Motor Options . . . . .	10.5
	Sensing Edge Switch . . . . .	5.8-5.9		Basic Electric Box Repair Parts . . . . .	10.6
	External Radio (Optional) . . . . .	5.10		Electric Box Layout . . . . .	10.7
	Motor Connection/ Safety Instructions . . . . .	5.11-5.13		Appendix B . . . . .	10.8
<b>Section 6</b>	<b>Operator Setup Procedures</b> . . . . .	<b>6.1-6.11</b>		Screw Terminal Assignments . . . . .	10.8
	Setting Close Direction . . . . .	6.2		Appendix C . . . . .	10.9-10.11
	Setting Braking Rate . . . . .	6.3		Run Codes . . . . .	10.9
	Setting Travel Limits . . . . .	6.4		Error Code . . . . .	10.10-10.11
	Alternate Method to Remotely Set Limits . . . . .	6.5	<b>Section 11</b>	<b>Warranty</b> . . . . .	<b>11.1</b>
	Setting Limit Overrun . . . . .	6.6			
	Setting Open & Close Modes . . . . .	6.7			
	(Optional) Transmitter Programming . . . . .	6.8			
	(Optional) Mid-Stop Limit Setting . . . . .	6.9			
	Resetting the MRT . . . . .	6.10			
	Monitored Reversing Devices . . . . .	6.11			

# Section 1: How to use this manual

The 11 sections of this Installation Manual provide the information required to install, troubleshoot and maintain this commercial/industrial door operator.

## Section 2

Provides important defining information related to safety terminology used throughout this manual, as well as safety related instructions which must be followed at all times while doing any steps/tasks/instructions detailed in this manual.

## Section 3

Details pre-installation concerns/issues/decisions that are recommended to be considered and/or resolved prior to beginning any commercial door operator installation.

### **WARNING**

**Failure to correctly perform all steps in sections 4-6 can result in serious injury or death.**

### **AVERTISSEMENT**

**Ne pas effectuer correctement toutes les étapes dans les sections 4-6 peut entraîner des blessures graves voire la mort.**

## Sections 4-6

Provides step by step installation and set-up instructions for this commercial door operator. Each section is written such that it must be followed in a step by step order to complete a successful installation.

## Sections 7-8

Details important features and troubleshooting information for typical installation and normal operations that may occur.

## Sections 9-11

Provides related information on service and maintenance items, operator drawings for use in troubleshooting and service activities, along with important warranty and returned goods policy information.



## Section 2: Safety Information & Instructions




### **⚠ WARNING**

Overhead Doors are large, heavy objects that move with the help of springs under high tension and electric motors. Since moving objects, springs under tension, and electric motors can cause injuries, your safety and the safety of others depend on you reading the information in this manual. If you have any questions or do not understand the information presented, call your nearest service representative. For the number of your local Overhead Door Dealer, call 800-929-3667, and for **Overhead Door® Factory Technical Advice, call 800-275-6187.**

In this Manual, the words Danger, Warning, and Caution are used to stress important safety information. The word:

- ⚠ DANGER** indicates an imminently hazardous situation which, if not avoided, will result in death or serious injury.
- ⚠ WARNING** indicates a potentially hazardous situation which, if not avoided, could result in death or serious injury.
- ⚠ CAUTION** indicates a potentially hazardous situation which, if not avoided, may result in injury or property damage.

*The word NOTE is used to indicate important steps to be followed or important considerations.*

POTENTIAL HAZARD	EFFECT	PREVENTION
 <b>MOVING DOOR</b>	<b>⚠ WARNING</b> <b>Could result in Serious Injury or Death</b>	<b>Do Not</b> operate unless the doorway is in sight and free of obstructions. Keep people clear of opening while door is moving. <b>Do Not</b> allow children to play with the door operator. <b>Do Not</b> change operator control to momentary contact unless an external reversing means is installed. <b>Do Not</b> operate a door that jams or one that has a broken spring.
 <b>ELECTRICAL SHOCK</b>	<b>⚠ WARNING</b> <b>Could result in Serious Injury or Death</b>	Turn off electrical power before removing operator cover. When replacing the cover, make sure wires are not pinched or near moving parts. Operator must be electrically grounded.
 <b>HIGH SPRING TENSION</b>	<b>⚠ WARNING</b> <b>Could result in Serious Injury or Death</b>	<b>Do Not</b> try to remove, repair or adjust springs or anything to which door spring parts are fastened, such as, wood block, steel bracket, cable or any other structure or like item. Repairs and adjustments must be made by a trained service representative using proper tools and instructions.

### **IMPORTANT**

**READ PRIOR TO ANY DOOR OPERATION**

1. **Read manual and warnings carefully.**
2. **Keep the door in good working condition. Periodically lubricate all moving parts of door.**
3. **If door has a sensing edge, check operations monthly. Make any necessary repairs to keep it functional.**
4. **AT LEAST twice a year, manually operate door. The Door should open and close freely. If it does not, the door must be taken out of service and a trained service representative must correct the condition causing the malfunction.**
5. **The Operator Motor is protected against overheating by an internal thermal protector. If the operator ceases to function because motor protector has tripped, a trained service technician may need to correct the condition which caused the overheating. When motor has cooled, thermal protector will automatically reset and normal operation can be resumed.**
6. **In case of power failure, the door can be operated manually by pulling the release cable to disconnect the operator drive system.**
7. **Keep instructions in a prominent location near the pushbutton.**

## Section 2: Safety Information & Instructions

### **⚠ AVERTISSEMENT**

Les portes basculantes sont de gros objets lourds qui fonctionnent à l'aide de ressorts soumis à une haute tension et de moteurs électriques. Dans la mesure où les objets en mouvement, les ressorts sous tension et les moteurs électriques peuvent entraîner des blessures, votre sécurité et celle des autres exigent que vous preniez connaissance des informations stipulées dans ce manuel. Si vous avez des questions ou si vous ne comprenez pas les informations ci-incluses, veuillez contacter le représentant de service le plus près. Pour obtenir le numéro du revendeur Overhead Door local, appelez le +1 (800) 929-3667, et pour obtenir des conseils techniques de l'usine Overhead Door, appelez le +1 (800)-275-6187.




Dans ce manuel, les mots Danger, Avertissement, et Attention sont utilisés pour faire ressortir d'importantes informations relatives à la sécurité. Le mot :

**⚠ DANGER** signale une situation dangereuse imminente qui si elle n'est pas évitée, risque d'entraîner des blessures graves, voire mortelles.

**⚠ AVERTISSEMENT** signale une situation potentiellement dangereuse qui, si elle n'est pas évitée, risque d'entraîner la mort ou des blessures graves.

**⚠ ATTENTION** signale une situation potentiellement dangereuse qui, si elle n'est pas évitée, risque d'entraîner des blessures ou des dommages matériels.

Le terme **REMARQUE** est utilisé pour signaler les étapes importantes à suivre ou d'importants éléments à prendre en considération.

DANGER POTENTIEL	EFFET	PRÉVENTION
 <p><b>PORTE EN MOUVEMENT</b></p>	<p><b>⚠ AVERTISSEMENT</b>  <b>Pourrait entraîner des blessures graves voire la mort</b></p>	<p>Utiliser uniquement si la porte est en vue et libre de tout obstacle. Ne laisser personne se tenir dans l'ouverture de la porte pendant qu'elle est en mouvement.            Ne pas permettre aux enfants de jouer avec l'opérateur de la porte.            Ne pas modifier la commande de l'opérateur à contact momentané à moins qu'un moyen d'inversion externe soit installé.            Ne pas faire fonctionner une porte qui bloque ou dont le ressort est cassé.</p>
 <p><b>CHOC ÉLECTRIQUE</b></p>	<p><b>⚠ AVERTISSEMENT</b>  <b>Pourrait entraîner des blessures graves voire la mort</b></p>	<p>Couper le courant avant d'enlever le couvercle de l'opérateur.            Lorsque le couvercle doit être remplacé, s'assurer que les fils ne sont ni coincés ni près des pièces mobiles.            L'opérateur doit être correctement mis à la terre.</p>
 <p><b>TENSION ÉLEVÉE DU RESSORT</b></p>	<p><b>⚠ AVERTISSEMENT</b>  <b>Pourrait entraîner des blessures graves voire la mort</b></p>	<p>Ne pas essayer d'enlever, réparer ni ajuster les ressorts ou toute autre pièce à laquelle le ressort de la porte est attaché, y compris blocs de bois, supports en acier, câbles ou autres articles semblables.            Les réparations et les réglages doivent être effectués par technicien qualifié qui se sert d'outils appropriés et qui respecte les instructions.</p>

## Section 3: Critical Installation Information

### Job Site Issues to Consider/Concerns

**The following list of items should be considered prior to selecting an operator for a given job site.**

1-Available power supply.

2-Type of door.

3-Potential operator mounting obstructions. Items to consider include, but are not limited to: side room, room above door shaft, room below door shaft, available mounting surface integrity, power supply location, and convenient chain hoist and release cable positioning.

4-Size of door for appropriate operator torque and door travel speed selection.

5-Operator mounting environment. Items to consider include operator location and dampness, dustiness and corrosiveness of the location.

6-Door activation needs/requirements. Examples include 3 button control stations, 1 button control stations, radio controls, pull cords, loop detectors, photoelectric controls, key switches, etc. See "Entrapment Protection" section below.

7-Interlock switches are required under certain conditions for doors with pass doors and door locks. See page 5.6.

8-Accessory equipment. Examples are reversing edges and/or photocell beams (required for doors set to operate as momentary contact), auxiliary control relays, warning lights, etc.

### **▲ ENTRAPMENT PROTECTION**

The installation of a fail safe external reversing device (such as a monitored reversing edge or photocell system, etc.) is required on all momentary contact electronically operated commercial doors. If such a reversing device is not installed, the operator will revert to a constant contact control switch for operation (Closing only).

The Reversing Devices currently UL Approved are:

- 1) MillerEdge ME and MT series monitored edge sensors used in combination with Timer-Close Module P/N OPABTCX.S
- 2) MillerEdge ME and MT series monitored edge sensors used in combination with MillerEdge Interface Module OPAKMEIGX.S. (Direct connect through STB inputs.)
- 3) MillerEdge Wireless monitored edge sensor OPAKMMWE.S.
- 4) Residential Safe-T-Beam® Monitored Photocells - P/N 37221R (OSTB-BX) and 38176R.S (includes extension brackets).
- 5) Series II Commercial Safe-T-Beam® Monitored Photocells - P/N OPAKPE.S and OPAKPEN4GX.S (NEMA 4).
- 6) Monitored Retro-Reflective Photoeye - P/N OPRAKRPEN4X.S

**▲ WARNING:** DO NOT apply line voltage until instructed to do so.

**▲ AVERTISSEMENT:** NE PAS mettre sous tension tant que l'instruction n'est pas donnée de le faire.

## Section 3: Critical Installation Information

**⚠ CAUTION:** Check working condition of door before installing the operator. Door must be free from sticking and binding. If equipped, deactivate any door locking device(s). Door repairs and adjustments, including cables and spring assemblies **MUST** be made by a trained service representative using proper tools and instructions.

**⚠ ATTENTION:** Vérifiez l'état de fonctionnement de la porte avant d'installer l'opérateur. La porte doit pouvoir bouger librement et ne pas coincer. Désactivez tous les dispositifs de verrouillage de la porte (si équipés). Les réparations et les réglages de porte, plus particulièrement pour les câbles et les ressorts **DOIVENT** être effectués par un technicien qualifié qui se sert d'outils appropriés et qui respecte les instructions.

### New Features:

**Voltmatic®** — Offers all (multiple) voltage combinations in single, 3-phase and separate 575, 3-phase voltage units.

**Limit Lock®** — Features patent pending electro-mechanical design that sets limits through the control panel that are maintainable even through a power outage.

## Section 3: Critical Installation Information

### ENTRAPMENT PROTECTION

The FireKing® can be used with the following UL Listed entrapment devices in compliance with UL325 requirements active starting August 29, 2010.

UNTIL ONE OF THESE MONITORED EXTERNAL ENTRAPMENT DEVICES IS INSTALLED, THE OPERATOR WILL NOT ALLOW MOMENTARY CONTACT OPERATION IN THE CLOSE DIRECTION.

LISTED DEVICES	ALLOWABLE DOOR WIDTH
MillerEdge ME & MT series monitored edge sensors used in combination with OPABTCX.S Timer-Close Module or MillerEdge Interface Module OPAKMEIGX.S. MillerEdge Wireless monitored edge sensor OPAKMMWE.S	ANY WIDTH
Residential Safe-T-Beams® P/N 37221R (OSTB-BX) and 38176R.S (includes ext. brkt's)	30 FEET
Commercial Photoeye Kit P/N OPAKPE.S and OPAKPEN4GX.S (NEMA 4)	
Monitored Retro-Reflective Photoeye Kit P/N OPAKRPEN4X.S	35 FEET

Slat Type	630 w/ RHX® Max SqFT Selection Guideline*									631 w/ RHX® Max SqFT Selection Guideline*		634 w/ RHX® Max SqFT Selection Guideline*						635 w/ RHX® Max SqFT Selection Guideline*		
	C-187			C-275			F-265			C-187	F-265	C-187		C-275		F-265		F-265		
Steel Gauge	22 gauge steel	20 gauge steel	18 gauge steel	22 gauge steel	20 gauge steel	18 gauge steel	16 gauge steel	22 gauge steel	20 gauge steel	18 gauge steel	24 gauge steel	24 gauge steel	20 gauge steel	18 gauge steel	20 gauge steel	18 gauge steel	20 gauge steel	18 gauge steel	24/24 gauge steel	22/24 gauge steel
1/2 HP	168	197	179	168	159	143	119	168	170	143	168	168	197	179	159	143	170	143	108	100
1 HP		279	233		219	189	159		227	189			279	233	219	189	227	189	151	135
3 HP		400	400		400	400	360		400	400			400	400	400	400	400	400	339	199

\* This chart is a general guideline to help minimize errors in the quoting process. A rolling fire door is a highly complex and configurable product. Consult factory when specifying horsepower for further accuracy.

## Section 3: Critical Installation Information

### **IMPORTANT INSTALLATION INSTRUCTIONS**

#### **WARNING-** To reduce the risk of severe injury or death:

- 1) READ AND FOLLOW ALL INSTALLATION INSTRUCTIONS.
- 2) Install only on a properly operating and balanced door. A door that is operating improperly could cause severe injury. Have qualified service personnel make repairs to cables, spring assemblies and other hardware before installing the operator.
- 3) Remove all pull ropes and remove, or make inoperative, all locks (unless mechanically and/or electronically interlocked to the power unit) that are connected to the door before installing the operator.
- 4) Install the door operator at least 8 feet above the floor if the operator has exposed moving parts.
- 5) Do not connect the door operator to the power source until instructed to do so.
- 6) Locate the control station: (a) within sight of the door, (b) a minimum of 5 feet above the floor so that small children cannot reach it, and (c) away from all moving parts of the door.
- 7) Install the Entrapment Warning Placard next to the control station and in a prominent location.
- 8) For products having a manual release, instruct the end user on the operation of the manual release.

### **IMPORTANT INSTRUCTIONS D'INSTALLATION**

#### **AVERTISSEMENT-** Pour réduire les risques de blessures graves ou de mort :

- 1) LIRE ET RESPECTER TOUTES LES INSTRUCTIONS D'INSTALLATION.
- 2) Installez uniquement sur une porte fonctionnant correctement et bien équilibrée. Une porte qui fonctionne mal peut provoquer des blessures graves. Demandez à un technicien qualifié d'effectuer les réparations des câbles, des ressorts et de toute autre quincaillerie avant de procéder à l'installation de l'opérateur.
- 3) Retirez toutes les cordes de traction ainsi que tous les verrous ou rendez-les inopérants (à moins qu'ils ne soient mécaniquement et/ou électroniquement interverrouillés à l'unité motrices) qui sont connectés à la porte avant de procéder à l'installation de l'opérateur.
- 4) Installez l'opérateur de la porte à 2,4 m minimum au-dessus du sol lorsque des pièces mobiles de l'opérateur sont exposées.
- 5) Ne pas raccorder l'opérateur de la porte à la source d'alimentation avant que l'instruction ne soit donnée de le faire.
- 6) Installez la station de commande : (a) en vue de la porte, (b) à 1,5 m minimum au-dessus du sol pour que les jeunes enfants ne puissent pas l'atteindre, et (c) à l'écart de toutes les pièces mobiles de la porte.
- 7) Installez le poster d'avertissement de pincement à côté de la station de commande à un endroit bien en vue.
- 8) Pour les produits ayant un déclenchement manuel, indiquez à l'utilisateur comment déclencher manuellement.

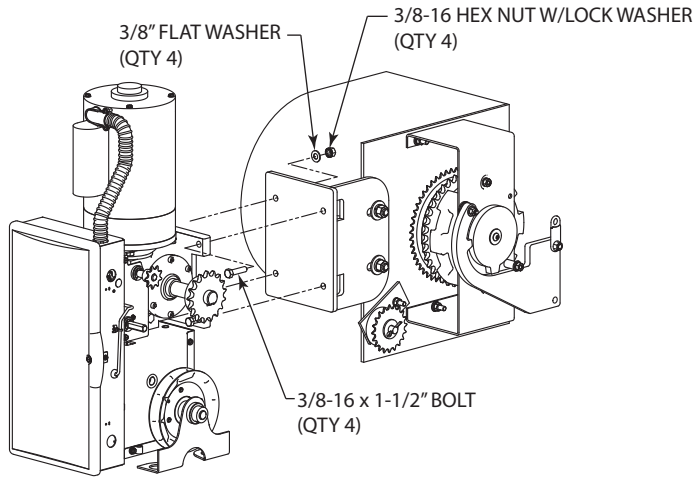
# Section 4: Installation

## General Overview. Be sure to follow all Warnings, Cautions and Notes.

The FireKing® Operator ships from the factory set up for a right hand installation. The unit can be converted for left hand installation by relocating the handwheel, release cord and limit drive to the opposite side of the powerhead. These changes are explained in the following installation instructions.

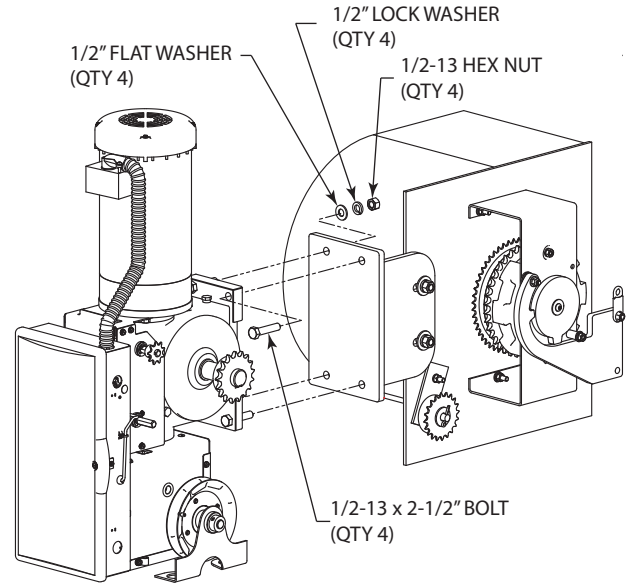
### Mounting the Operator

- 1) Mount the powerhead to the headplate mounting bracket using the fasteners provided. See FIG. 4-1 below.



**1/2 and 1 HP Operator**

**Figure 4.1**

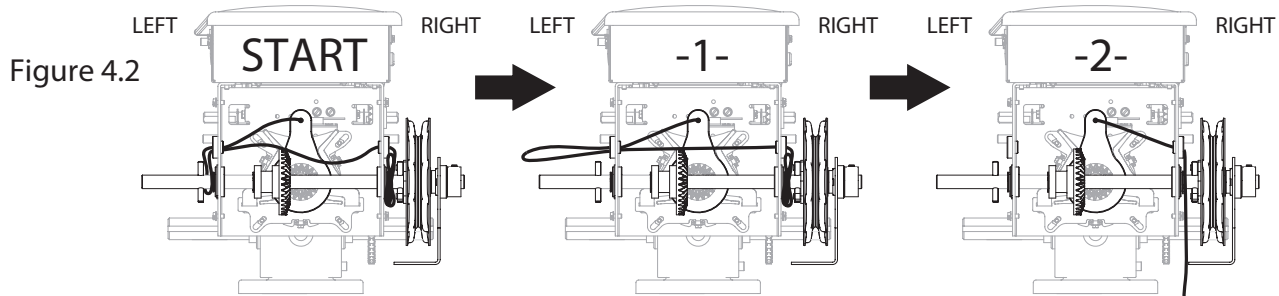


**3 HP Operator**

# Section 4: Installation

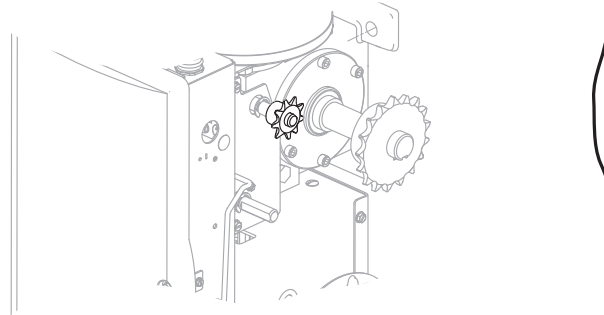
## Mounting the Operator RIGHT HAND INSTALL

2) For right-hand installs, unloop the release cord from the left side of the hoist shaft and pull it through the right side of the enclosure. FIG. 4-2.



Install the 9 tooth #410 sprocket on the upper limit shaft on the right side of the powerhead. FIG. 4-3. DO NOT TIGHTEN SET SCREW AT THIS TIME.

Figure 4.3



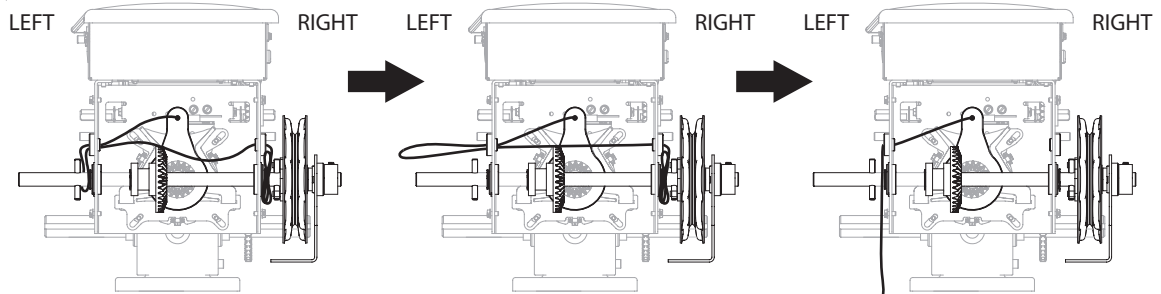


# Section 4: Installation

## Mounting the Operator LEFT HAND INSTALL

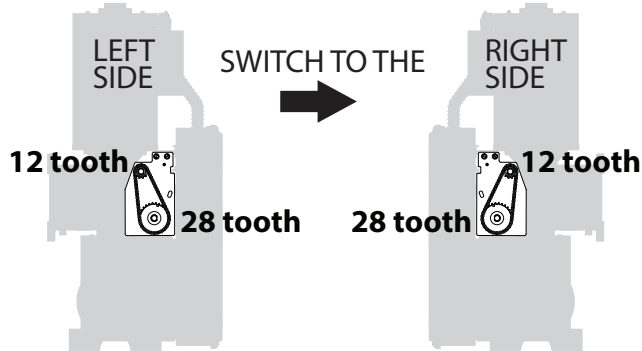
3) For Left-hand installs, pull the release cord through the left side of the enclosure. FIG. 4.4.

Figure 4.4



Remove the 12 tooth and 28 tooth limit sprockets and chain from the left side of the powerhead and reinstall on the right side of the powerhead with the 12 tooth sprocket on the upper limit shaft and the 28 tooth sprocket on the lower limit shaft. FIG. 4-5.

Figure 4.5

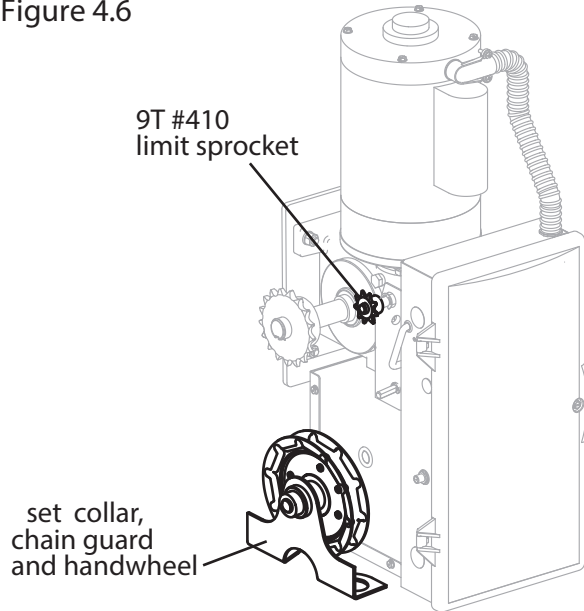


# Section 4: Installation

## Mounting the Operator LEFT HAND INSTALL

- 4) Remove the set collar, chain guard and handwheel from the right side of the unit and re-install them on the left side. FIG. 4.6. Install the 9T #410 limit sprocket on the upper limit shaft on the left side of the powerhead. DO NOT TIGHTEN SET SCREW AT THIS TIME.

Figure 4.6



## DRIVE CHAIN

- 5) Wrap the #50 drive chain around the door sprocket and the drive sprocket on the operator and install the master link. FIG. 4.7 & 4.8.

### MASTER LINK

Figure 4.7

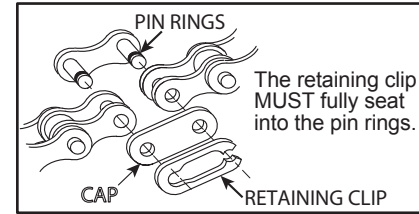
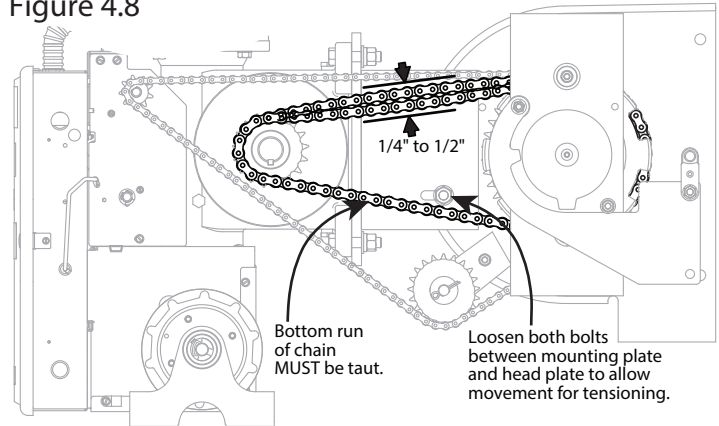


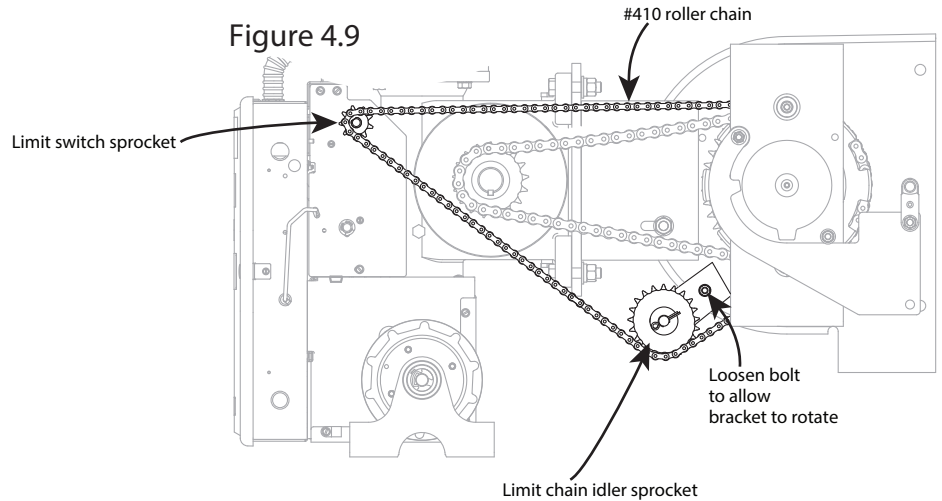
Figure 4.8



## Section 4: Installation

### Mounting the Operator LIMIT CHAIN

- 5) Loosen the bolt on the limit chain idler bracket (FIG 4.9 ) to let the bracket rotate freely. Wrap the #410 limit chain around the limit drive sprocket on the door, the limit idler sprocket and the 9 tooth limit sprocket on the operator and install the master link. Make sure the sprockets are aligned and tighten the set screws on the 9 tooth sprocket. Rotate the limit chain idler bracket to apply tension to the #410 chain and tighten the limit idler bracket bolt.



## Section 4: Installation

### Mounting the Operator HAND CHAIN

- 6) Route the hand chain through the chain guide, around the sprocket wheel and back through the opposite side of the chain guide as shown in FIG. 4.10. Connect the hand chain ends together as shown in FIG. 4.11 by twisting open the last link on one end of the chain and slipping the last link on the opposite end into the open link. Twist the open link closed again. Mount the chain keeper to the wall, in line with handwheel and approximately 4 feet off the floor. Loop the chain around the keeper as shown in FIG. 4.12. Optional padlock not provided.

Figure 4.10

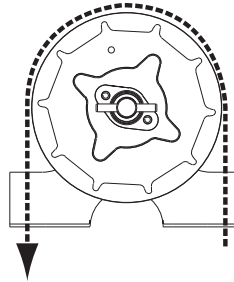


Figure 4.11

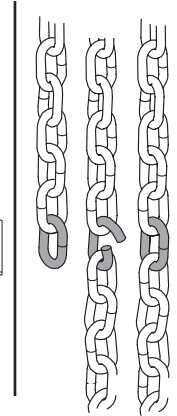
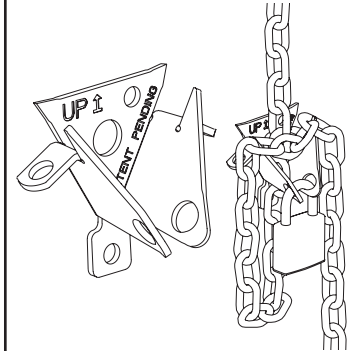
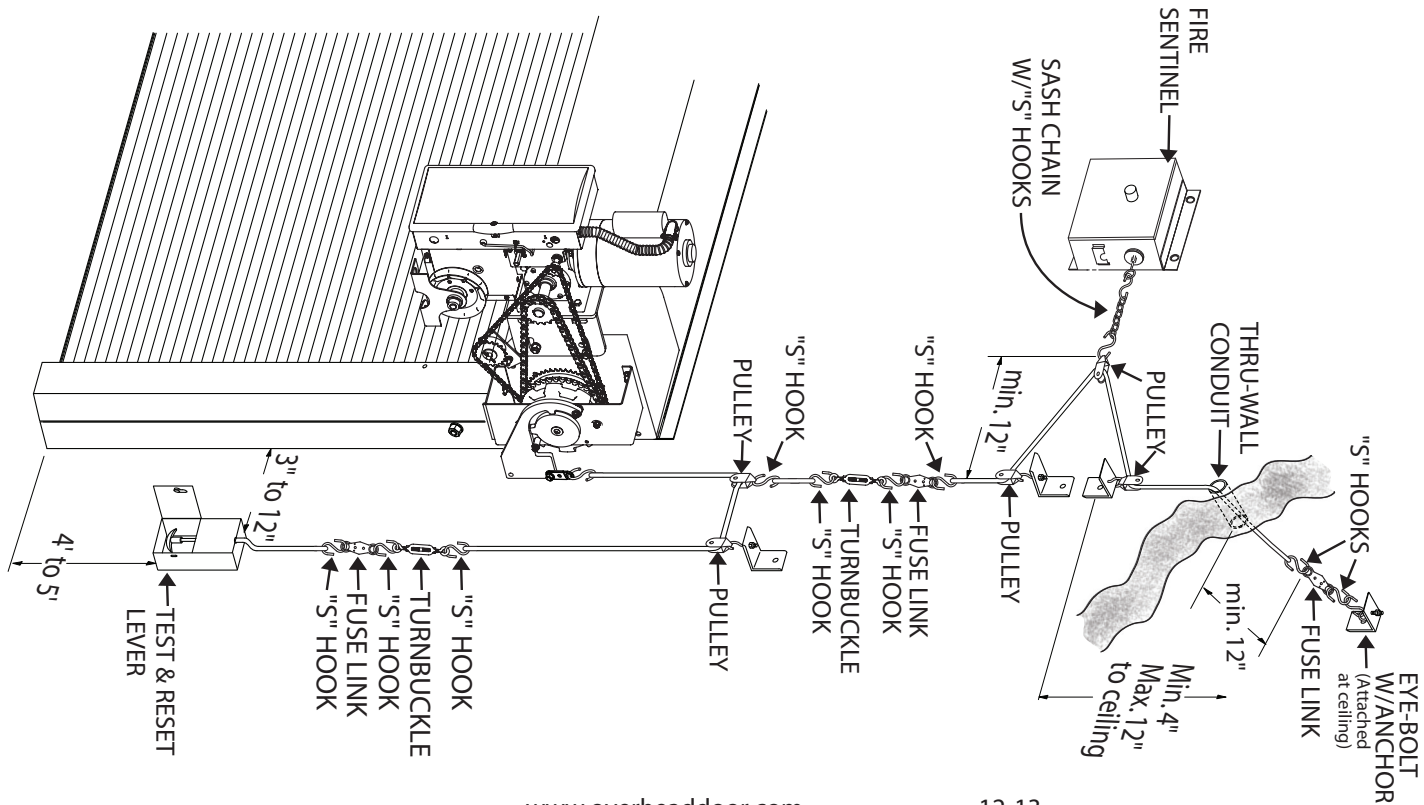


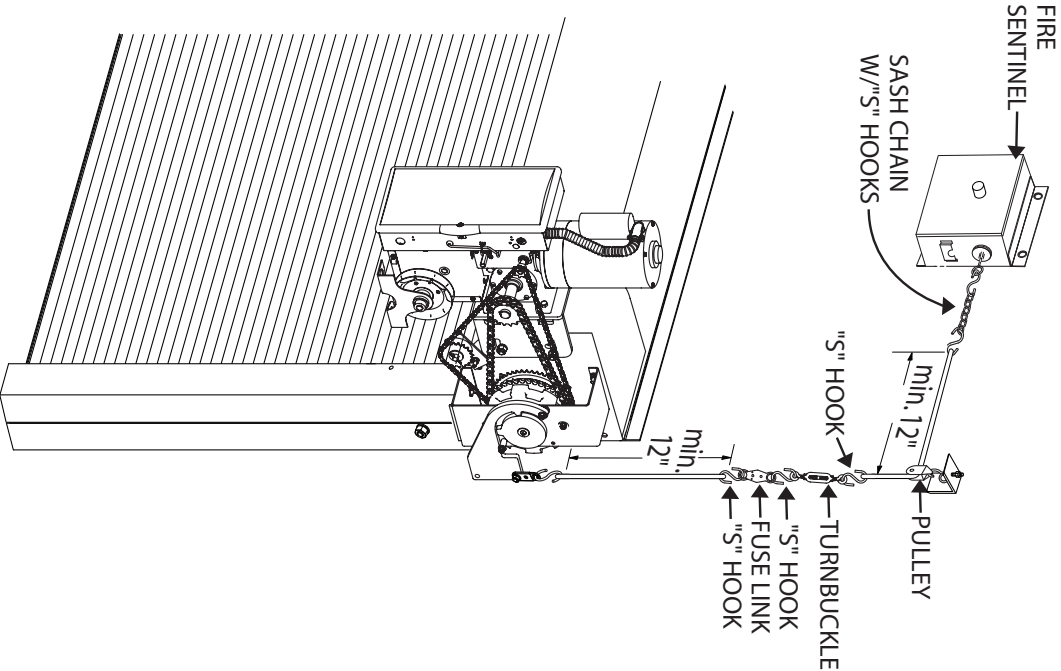
Figure 4.12



**OPTIONAL Fire Door Release Assembly with Fire Sentinel  
and thru-wall release**  
RH Drive shown, LH Drive opposite



**OPTIONAL Fire Door Release Assembly with Fire Sentinel  
RH Drive shown, LH Drive opposite**



## Section 5: Wiring

### **⚠ WARNING**

- DO NOT apply power to operator until instructed to do so.
- It is strongly recommended, and may be required by law in some areas, that line voltage wiring be performed by a qualified electrician.
- Be sure that electrical power has been disconnected from the input power wires being connected to the operator prior to handling these wires. An appropriate lock-out/tag-out procedure is recommended.
- Line voltage wiring must meet all local building codes.
- Make sure operator voltage, phase and frequency nameplate ratings are identical to the job site line voltage ratings.
- Input power wiring must be properly sized for the operators amperage rating located on the nameplate.
- To reduce the risk of electric shock, make sure the chassis of this unit is properly grounded.

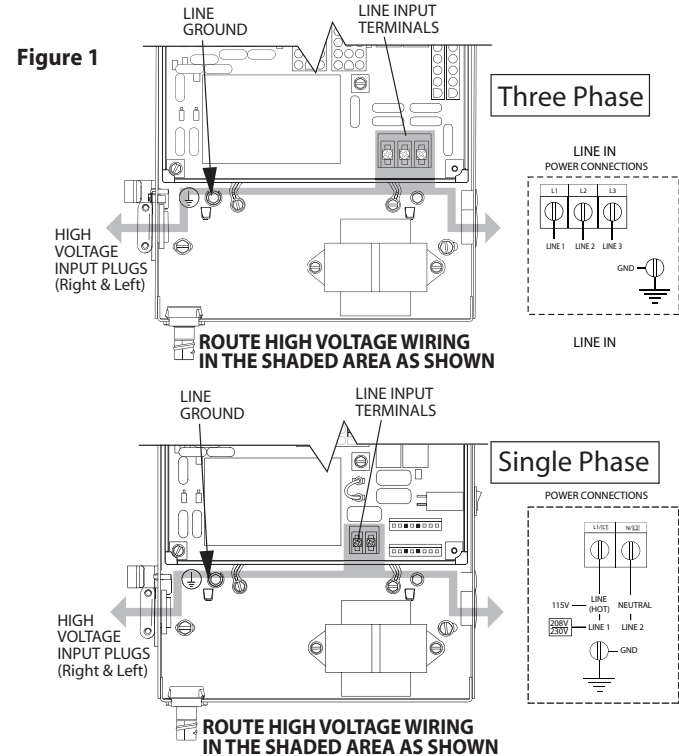
### **⚠ AVERTISSEMENT**

- NE PAS mettre sous tension tant que l'instruction n'est pas donnée de le faire.
- Il est fortement recommandé voire même exigé par la loi dans certaines régions, de contacter un électricien qualifié pour l'acheminement du fil électrique.
- Assurez-vous que l'alimentation électrique a été déconnectée des câbles d'alimentation d'entrée connectés à l'opérateur avant de manipuler ces câbles. Une procédure de verrouillage/étiquetage appropriée est recommandée.
- Le câblage au secteur doit satisfaire à tous les codes de construction locaux.
- Assurez-vous que les valeurs nominales de la plaque signalétique pour tension, phase et fréquence de l'opérateur correspondent à celles des tensions de l'alimentation sur site.
- La capacité d'entrée doit correspondre à la valeur nominale de l'ampérage des opérateurs indiquée sur la plaque signalétique.
- Pour réduire le risque de choc électrique, assurez-vous que le châssis de l'unité est correctement mis à la terre.

# Section 5: Wiring

## Line Voltage Wiring Fig. 1

- 1) Remove LINE VOLTAGE INPUT PLUG and install proper fittings and 1/2" conduit.
- 2) Route proper LINE VOLTAGE wires into operator.
- 3) Locate LINE INPUT terminals on circuit board. Using correct connectors, attach wires to LINE INPUTS, and GROUND terminal.
  - Keep low voltage and line voltage wires separate.
  - Route all line voltage wires as shown.
  - Plug all unused conduit holes.

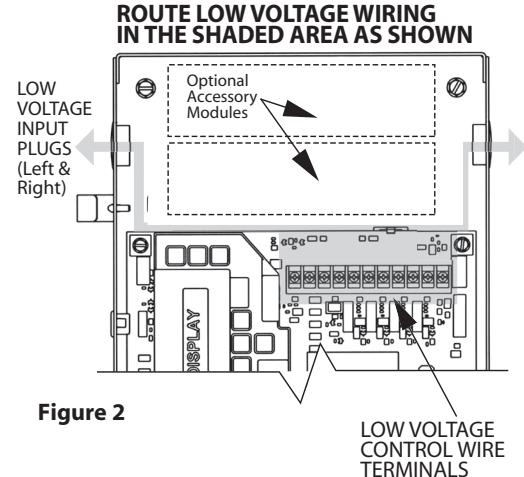




## Low Voltage Control Wiring (general) Fig. 2

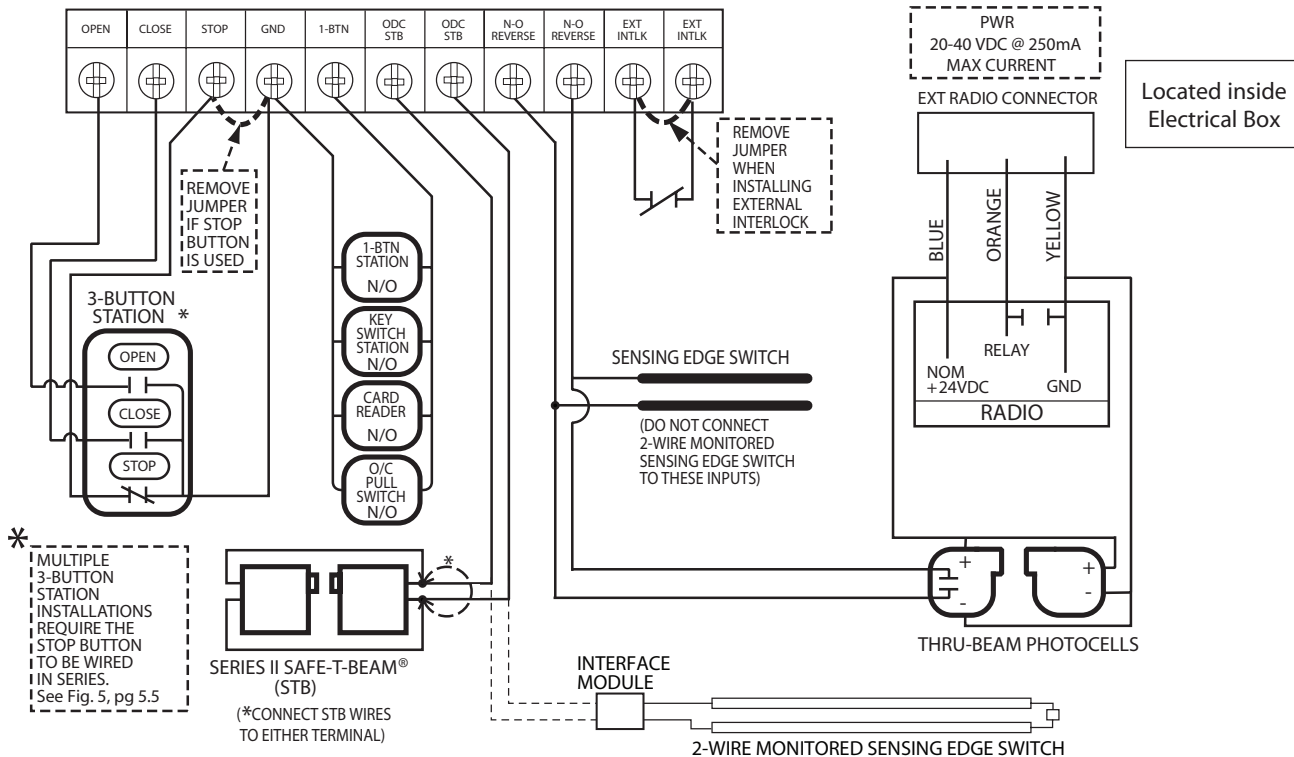
- 1) Connect all LOW VOLTAGE control circuit wires to this side of unit using 1/2" conduit or flexible convoluted tubing.
  - Keep low voltage and line voltage wires separate.
  - Route all low voltage control wiring as shown. This includes all control circuit wires such as wall controls, timers and single button input devices as well as radio control and safety circuit wiring. See Figs 2 through 13 in this section.
  - Plug all unused conduit holes.

**NOTE:** For a detailed description of control wire terminals see Appendix B.



## External Wire Diagram

See Appendix B for detailed description of terminals.



## Wall Control

### ⚠️ WARNING:

- Wall Control(s) must be located so that the door is within sight of the user and is far enough from the door, or positioned such that the user is prevented from coming in contact with the door while operating controls.
- Attach the Warning placard adjacent to the Wall Control. **Fig. 3A.**

### ⚠️ AVERTISSEMENT:

- La ou les commandes murales doivent être situées de telle sorte que l'utilisateur puisse voir la porte et positionnées de telle sorte que l'utilisateur ne puisse pas entrer en contact avec la porte lorsqu'il se sert des commandes.
- Fixez le poster d'avertissement à côté de la commande murale. **Fig. 3A.**

### ⚠️ WARNING:

Before momentary contact control can be used on the CLOSE button, a monitored external reversing device such as a photocell system or sensing edge switch must be used. See pages 5.7-5.9 for installation of entrapment protection devices.

### ⚠️ AVERTISSEMENT:

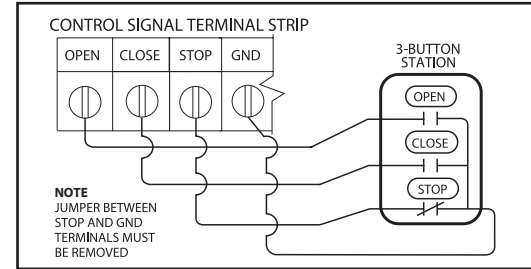
Avant d'utiliser la commande à contact momentané sur le bouton FERMETURE, un dispositif d'inversion externe surveillée tel qu'un système de cellule photoélectrique ou un commutateur de détection de bord doit être utilisé. Voir l'installation des dispositifs de protection contre le coincement en pages 5.7-5.9.

- 1) For a single 3-button installation, make connections as shown in **Fig. 3.**
- 2) For single button accessory controls, make connections as shown in **Fig. 4.**
- 3) For multiple 3-button installations, make connections as shown in **Fig. 5.**

**Figure 3A**



Entrapment  
Warning Placard

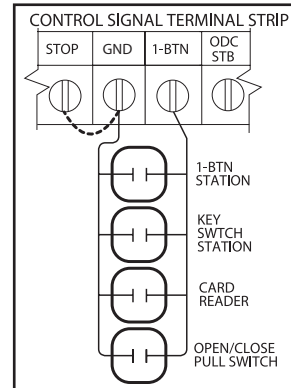


**Figure 3**

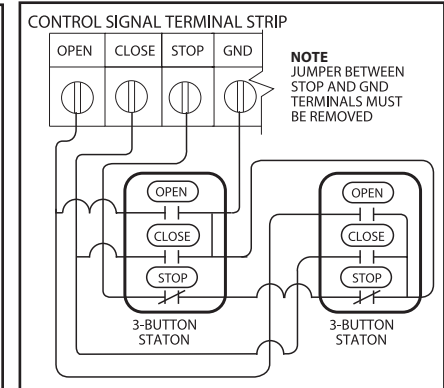
**NOTE:** If an External STOP button is NOT being installed, a jumper wire must be installed between the "STOP" and "GND" terminals as shown.

**NOTE:** Long Distance Relay Kit wiring is not required for long distance control runs and should not be used.

**Figure 4**

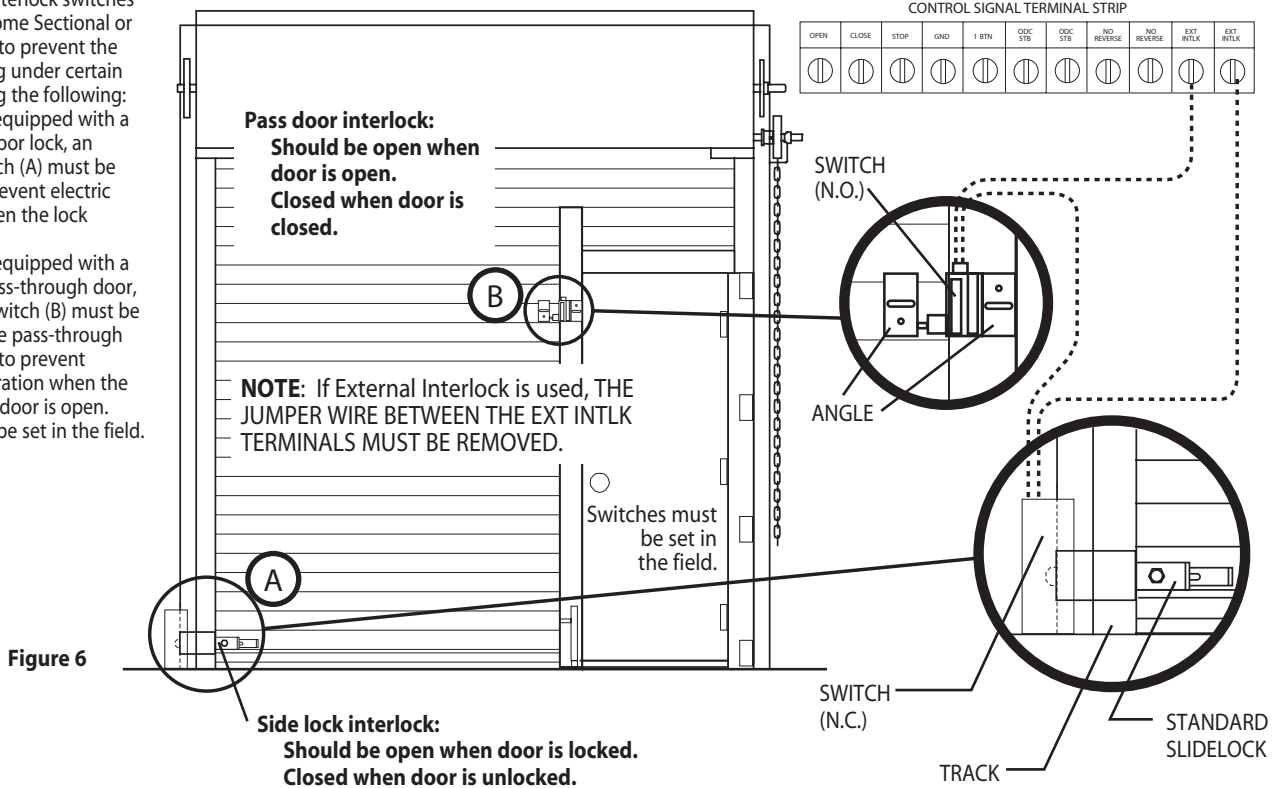


**Figure 5**



## Interlock Switches

- 1) Optional external interlock switches are required with some Sectional or Rolling Steel Doors to prevent the door from operating under certain conditions including the following:
  - If the door is equipped with a functioning door lock, an interlock switch (A) must be installed to prevent electric operation when the lock is engaged.
  - If the door is equipped with a pedestrian pass-through door, an interlock switch (B) must be installed at the pass-through door in order to prevent electrical operation when the pass-through door is open.
- 2) The Switches must be set in the field.



## Photocell Wiring

### Series II Safe-T-Beam® Monitored Photocells

- 1) Monitored SERIES II (STB) photocells (P/N OPAKPE.S) and Residential Safe-T-Beam® Monitored Photocells from Overhead Door® (P/N 37221R & 38176R.S). **Fig. 7.** Wiring to these photocells can be connected to either terminal (they are not polarity sensitive.) (**Troubleshooting in Section 8**)

**NOTE:** Installer must enable ODC STB in calibration mode. See page 6.11.

**⚠ WARNING:** Actuating the operator by using constant contact on the CLOSE button will override non-functioning external reversing devices, including photocells.

**⚠ AVERTISSEMENT:** L'activation de l'opérateur en utilisant un contact constant sur le bouton FERMER annulera les dispositifs d'inversions externes, y compris les cellules photoélectriques.

- 2) **To Mount Photocells:** (Kit includes detailed Instructions).
  - Determine location for mounting. They do not need to be directly adjacent to the door but must be somewhere along the wall where there will be an unobstructed line between them. **Fig. 9.**
  - They must extend out away from the wall sufficiently that no door hardware breaks the plane of the photo-beam.

**⚠ WARNING:** Photocell systems provide entrapment protection when mounted near the doorway in such a way that the lower portion of an individual's leg will break the photocell beam during normal walking conditions.

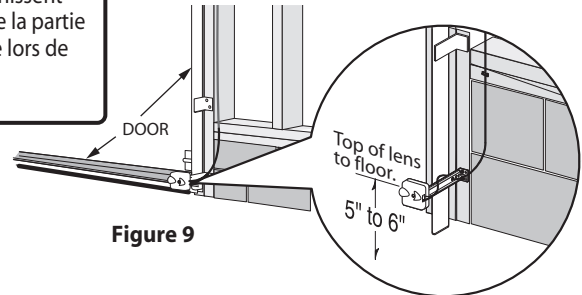
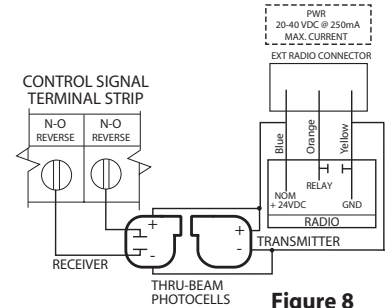
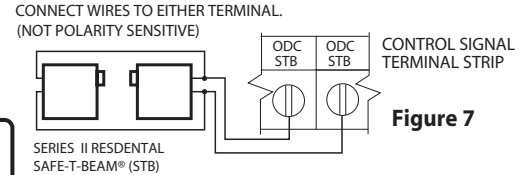
**⚠ AVERTISSEMENT:** Les systèmes de cellules photoélectriques fournissent une protection contre le coincement pour le montage à proximité de la porte de manière à ce que la partie inférieure de la jambe d'un individu ne puisse pas rompre le faisceau de la cellule photoélectrique lors de passages normaux par la porte.

### Commercial Non-Monitored Photocells

- 1) Nominal 24 Volt DC Commercial photocells with normally open contacts can be connected as shown in **Fig. 8.**

**NOTE:** Blue wire supplies 20 – 40VDC. Photocells used must be compatible with this voltage range.

**NOTE:** If no voltage is present at Blue wire, check fuse F-1 on Control board.



## Sensing Edge Installation

**Figure 11** shows an example of a typical sensing edge installation. Left hand side is shown but right hand is a mirror image of this.

- 1A) If the wiring from the sensing edge enclosure to the operator is a coiled cord or 2 wire jacketed cord:
  - Install junction box 12" above the center of the door opening on same side as sensing edge enclosure.
  - Secure one end of cord to junction box using a cable clamp.
- 1B) If connection is to be made through a take up reel cord:
  - Install on same side as sensing edge enclosure and above door opening and slightly to the side.
  - Install junction box adjacent to take up reel and route the stationary cord from the reel to the box and secure with a cable clamp.

**NOTE:** DO NOT USE TAKE UP REEL IF INSTALLING A 2 WIRE MONITORED EDGE.

- 2) Secure other end of cord (straight, coiled or reel) to sensing edge enclosure using a cable clamp.
- 3) Connect wires of cord to sensing edge using wire nuts or other suitable wire connectors.
- 4) Run a straight 2 wire cord from the junction box (Step 1) to the operator electrical box.
  - Secure using cable clamp on each end.
- 5) Join wires in cord from operator to wires in cord from junction box using wire nuts or other suitable wire connectors.
- 6A) **Non-Monitored** sensing edge connects to terminal strip on main board using (N-O REVERSE) terminals. See **Fig. 10A**.
- 6B) **Monitored** sensing edge connects to Timer-Close Module terminals (MON EDGE and GND) or to (ODC STB) terminals on main board through a MillerEdge Interface Module as shown in **Fig. 10B**.

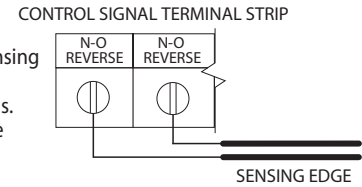
**⚠ WARNING:** Actuating the operator using constant contact on the CLOSE button will override non-functioning external reversing devices, including sensing edges.

**⚠ AVERTISSEMENT:** L'activation de l'opérateur avec un contact constant sur le bouton FERMER annulera les dispositifs de renversement externes non fonctionnels, y compris les systèmes de détection des bords.

CONTINUED ON NEXT PAGE

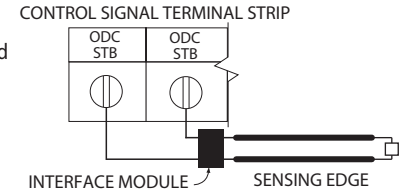
**Figure 10A**

**NOTE:** Non-monitored Pneumatic or Electric Sensing Edge can be connected directly to these terminals. DO NOT connect a 2-wire Monitored Sensing Edge to these terminals.

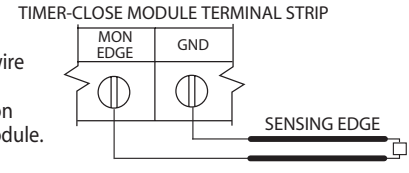


**Figure 10B**

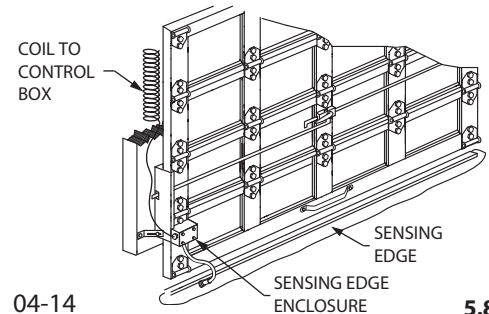
**NOTE:** 2-wire Monitored Sensing Edge must be connected through the MillerEdge Interface Module.



**NOTE:** Monitored 2-wire Sensing Edge can also be used in combination with a Timer-Close Module.



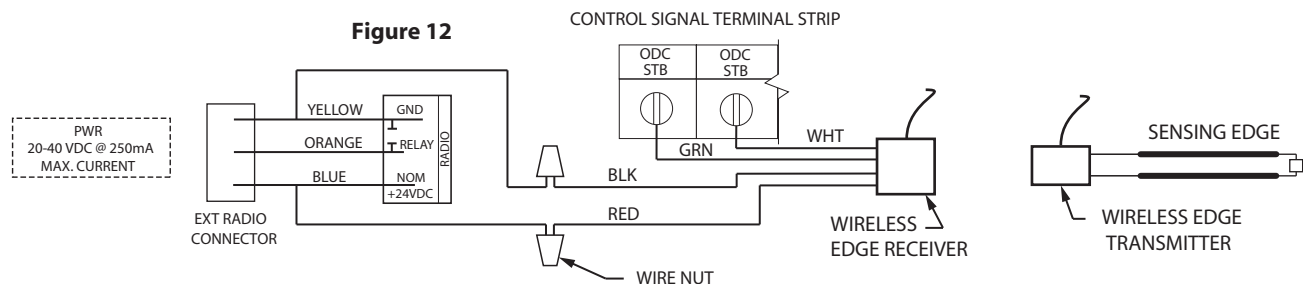
**Figure 11**



## Sensing Edge Installation (continued)

- 7) Operate the door to make certain cord is free to travel and does not become snared during door opening or closing.
  - Check sensing edge for proper operation.
- 8) While the door is closing actuate the sensing edge to verify the door reverses to open limit.

Figure 12 shows the connection of OPAKMMWE.S MEL Miller Edge Monitored Wireless Sensing Edge.



**⚠ WARNING:** To obtain proper operation of the MEL edge sensor, each transmitter/receiver set must be set to a unique address. Follow instructions provided with the Miller Edge MEL kit to set the address.

**⚠ AVERTISSEMENT:** Pour obtenir un fonctionnement correct du capteur de bord MEL, réglez chaque ensemble émetteur/récepteur sur une adresse unique. Suivez les instructions fournies avec le kit Miller Edge MEL pour définir l'adresse.

## External Radio Installation

Although these operators are equipped with an internal radio, they also provide a universal connection for an external radio.

### To Add the External Radio

- 1) Plug the pigtail with the 3 wires attached (provided) onto the plug connector marked "EXT RADIO." **Fig. 13.**
- 2) Make wiring connections to the wires per the diagram below.

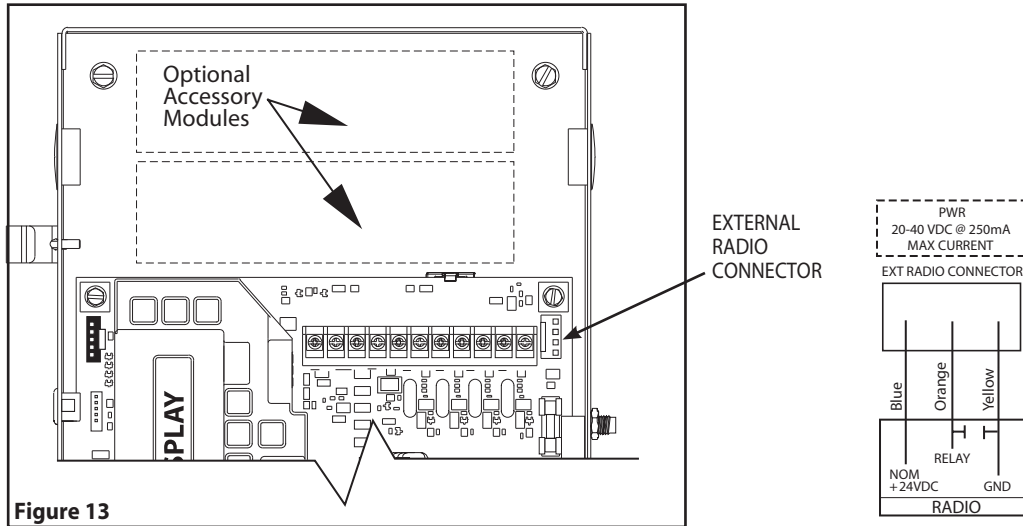


Figure 13



## Motor Connection

### ⚠ WARNING:

Verify Line Voltage before making any connections to assure that motor harness is connected to proper motor connector on circuit board.

### ⚠ AVERTISSEMENT:

Vérifiez la tension avant d'effectuer les connexions pour s'assurer que le harnais du moteur est relié au connecteur du moteur appropriée sur la carte du circuit.

- 1) Plug motor harness into proper motor connector on circuit board in electric box. **Fig. 14.**
- 2) Apply primary power.

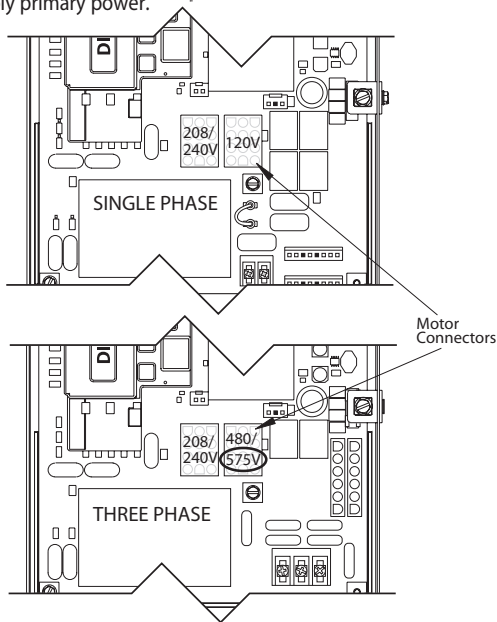


Figure 14

### ⚠ DANGER:

After power is supplied to the operator, **Do Not** make contact with components inside the control panel except for the Keypad Keys. **Fig. 1, pg. 6.1.**

### ⚠ DANGER:

Après avoir mis l'opérateur sous tension, **NE PAS** entrer en contact avec des composants à l'intérieur du panneau de commande, sauf pour les touches du pavé numérique. **Fig. 1, pg. 6.1.**

# IMPORTANT SAFETY INSTRUCTIONS

**WARNING-**  
To reduce the risk of severe  
injury or death:

- 1) READ AND FOLLOW ALL INSTRUCTIONS.
- 2) Never let children operate or play with door controls. Keep the remote control (where provided) away from children.
- 3) Personnel should keep away from a door in motion and keep the moving door in sight until it is completely closed or opened. NO ONE SHOULD CROSS THE PATH OF A MOVING DOOR.
- 4) Test the door's safety features at least once a month. After adjusting either the force or the limit of travel, retest the door operator's safety features. Failure to adjust the operator properly may cause severe injury or death.
- 5) For products having a manual release, if possible, use the manual release only when the door is closed. Use caution when operating the release while the door is open. Weak or broken springs may cause the door to fall rapidly, causing severe injury or death.
- 6) KEEP DOOR PROPERLY OPERATING AND BALANCED. See Door Manufacturer's Owner's Manual. An improperly operating or improperly balanced door could cause severe injury or death. Have only trained door systems technicians make repairs to cables, spring assemblies, other hardware and any wooden blocks or like items to which they may be attached.
- 7) SAVE THESE INSTRUCTIONS.

## **CONSIGNES DE SÉCURITÉ IMPORTANTES**

### **AVERTISSEMENT- Pour réduire les risques de blessures graves ou de mort :**

- 1) LIRE ET RESPECTER TOUTES LES INSTRUCTIONS.
- 2) Ne jamais permettre aux enfants d'actionner ni de jouer avec les commandes de la porte.  
Tenir les télécommandes (si fournies) hors de la portée des enfants.
- 3) Le personnel doit se tenir à l'écart d'une porte en mouvement et garder bien en vue une porte en mouvement jusqu'à ce qu'elle soit complètement fermée ou ouverte. **PERSONNE NE DOIT TRAVERSER LA TRAJECTOIRE D'UNE PORTE EN MOUVEMENT.**
- 4) Testez les fonctionnalités de sécurité de la porte au moins une fois par mois. Après avoir réglé la force ou la limite de la course, retestez les éléments de sécurité de l'opérateur de la porte. Un mauvais réglage de l'ouvre-porte peut entraîner des blessures graves voire la mort.
- 5) Pour les produits ayant un déclenchement manuel, dans la mesure du possible, utilisez le déclenchement manuel uniquement lorsque la porte est fermée. Prenez toutes les précautions nécessaires lors de l'utilisation du déclenchement manuel alors que la porte est ouverte. Des ressorts faibles ou brisés peuvent faire descendre la porte rapidement ce qui peut entraîner des blessures graves voire la mort.
- 6) **VEILLER À CE QUE LA PORTE SOIT CORRECTEMENT ÉQUILIBRÉE ET FONCTIONNE BIEN.** Consultez le manuel de l'utilisateur du fabricant de la porte. Une porte déséquilibrée ou fonctionnant incorrectement pourrait entraîner de graves blessures voire la mort. Seuls des techniciens formés sur systèmes de portes peuvent effectuer des réparations aux câbles, aux ressorts, aux autres matériels et aux blocs de bois ou éléments semblables auxquels ces éléments peuvent être attachés.
- 7) **CONSERVER CES CONSIGNES.**

# Section 6: Operator Setup Procedure

## Control Panel

These operators include a full function control panel including a liquid crystal display (LCD), calibration keys and Open, Close and Stop keys for on board operator control. See **Fig. 1**. The open, close and stop keys function as a 3-button wall control. The Display will show current operator conditions and calibration information. Due to limited character space, some displays will be abbreviated. See Appendix C (pgs. 10.9-10.11) for full display descriptions.

Operators also include a non-volatile memory. The unit will remember all calibration settings plus error code and run code logs, if power is removed from unit.

**⚠ DANGER:** After power is supplied to the operator, **Do Not** make contact with components inside the control panel except for the Keypad Keys. **Fig. 1**.

**⚠ DANGER:** Après avoir mis l'opérateur sous tension, **NE PAS** entrer en contact avec des composants à l'intérieur du panneau de commande, sauf pour les touches du pavé numérique. **Fig. 1**.

**AFTER WIRING HAS BEEN COMPLETED, TURN ON POWER TO THE OPERATOR.**

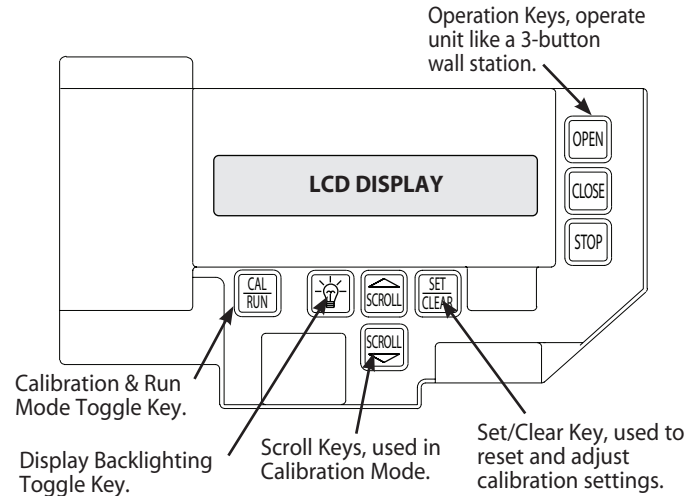
### Control Operating Modes

Operator control boards operate in two modes: Run Mode and Calibration Mode. The control board should normally operate in the Run Mode. The operator is calibrated in Calibration Mode.

#### With the operator standing idle:

PRESS CAL/RUN TO TOGGLE BETWEEN OPERATING MODES.

- The first display in calibration mode is "set close dir."
- The display in run mode will be one of the condition codes listed in Appendix C.



**Figure 1**

**⚠ WARNING:** DO NOT calibrate operator or operate door unless doorway is in sight and free obstructions. Door will move during setup. Keep people clear of opening while door is moving.

**⚠ AVERTISSEMENT:** Calibrer l'opérateur et utiliser la porte uniquement si la porte est en vue et libre de tout obstacle. La porte se déplacera pendant la programmation. Ne laisser personne se tenir dans l'ouverture de la porte pendant qu'elle est en mouvement.

## Setting Close Direction

The direction of motor rotation depends on mounting position and/or how the main input power phases are wired. This setting is used to insure the door is closing and opening according to the input commands.







- 1) If operator is in RUN mode, press CAL/RUN  to enter calibration mode.
- 2) Press SET/CLEAR  to begin the calibration procedure and advance to the next screen. **Figure 3.**
- 3) Briefly press the CLOSE  key. (Pressing the Scroll key at this point will exit this control function.)
  - The display will read “ DID DOOR CLOSE? ” **Figure 4.**
- 4) Press SCROLL  key (up or down) to toggle between YES and NO. **Figure 5.**
  - If YES is selected, no change to operator calibration is made. If NO is selected — the POD will change the operator's down direction.
- 5) Press the SET/CLEAR  key.
- 6) Press CAL/RUN  to return to run mode.

Figure 2

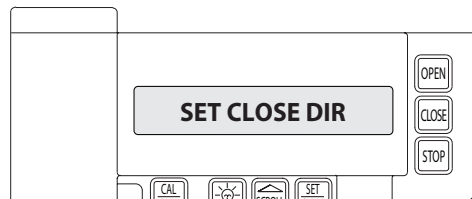


Figure 3

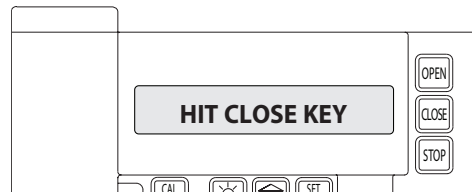
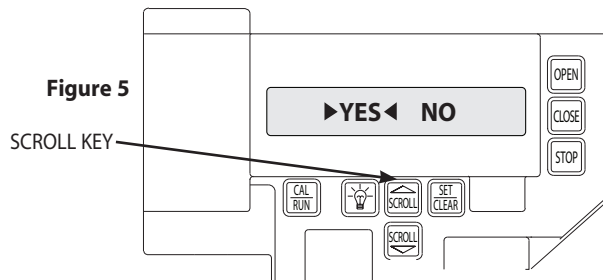






Figure 4



Figure 5



## Setting Braking Rate

- 1) If operator is in RUN mode, press CAL/RUN  to enter calibration mode.
- 2) Press Scroll until display reads "BRAKING RATE >#." where # is the deceleration rate, ranging from 0 to 9.  
0 = MAX braking, 9 = MIN braking. **Figure 6.**
- 3) Press SET/CLEAR  key to toggle between 0 and 9—one digit at a time.
- 4) Pick a value and operate the door. Adjust as necessary.
- 5) Press a SCROLL  key to shift to a new function and lock in the setting.
- 6) Press CAL/RUN  to return to run mode.

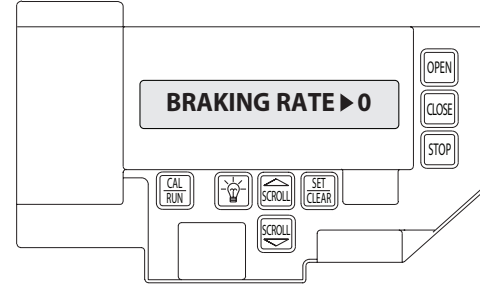









Figure 6








## Setting Travel Limits

### UP and/or DOWN

- 1) If operator is in RUN mode, press CAL/RUN  to enter calibration mode.
- 2) Press SCROLL  until display reads "UP LIMIT>CLR " or "DOWN LIMIT>CLR " **Figure 7.**
- 3) Jog the door using the OPEN  or CLOSE  key until you reach the desired height.
- 4) Press SET/CLEAR  key to switch display to "UP LIMIT>SET " or "DOWN LIMIT>SET ." **Figure 8.**
- 5) Press a SCROLL  key to shift to a new function and lock in the limit setting.
- 6) Press CAL/RUN  to return to run mode.

## Resetting Travel Limits

### UP and/or DOWN

- 1) If operator is in RUN mode, press CAL/RUN  to enter calibration mode.
- 2) Press SCROLL  until display reads "UP LIMIT>SET " or "DOWN LIMIT>SET ." **Figure 8.**
- 3) Press SET/CLEAR  to switch display to "UP LIMIT>CLR " or "DOWN LIMIT>CLR "
- 4) Jog the door using the OPEN  or CLOSE  key until you reach the desired height.
- 5) Press SET/CLEAR  to switch display to "UP LIMIT>SET " or "DOWN LIMIT>SET "
- 6) Press CAL/RUN  to return to run mode.

**NOTE:** The recommended setpoint for the DOWN Travel Limit is normally at approximately 2 inches off the floor. This final distance will be covered by the Limit Overrun Function to establish a more accurate seal.

**NOTE: SEE PAGE 6.5 FOR AN ALTERNATE METHOD OF SETTING LIMITS**

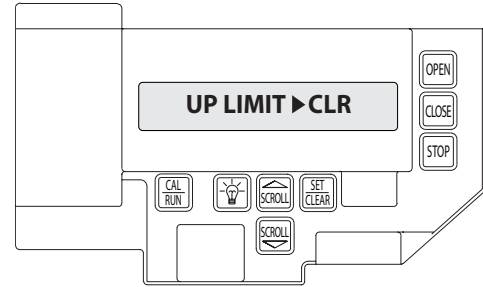


Figure 7

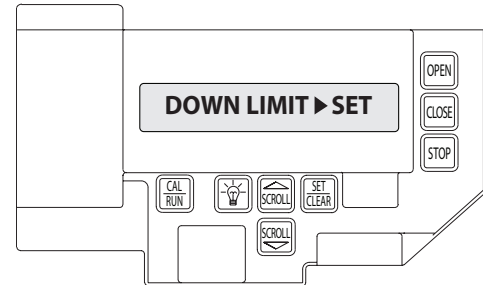


Figure 8

## Alternate Method for Remotely Setting all Limits

*This method will not clear or change an already set limit. To use this method you must first clear the existing limit setpoint.*

- 1) Using the OPEN,CLOSE, STOP buttons on the Wall Station, place the door in the desired position for the limit you wish to set (UP, DOWN or MID-STOP).
- 2) With the door stopped and in desired position:
  - Press and hold the STOP button for, at least 10 seconds. **DO NOT press any other button.**

**NOTE:** Following the setting of a limit you will hear the operator move for a split second as it confirms the setting.

- 3) While still holding the STOP button:
  - To set the **Up Limit**
    - a. Press and hold the OPEN button for one second.
    - b. Release the STOP button, then release the OPEN button.
  - To set the **Down Limit**
    - a. Press and hold the CLOSE button for one second.
    - b. Release the STOP button, then release the CLOSE button.
  - To set the **Mid-Stop Limit**
    - a. Press and hold both OPEN and CLOSE buttons for one second.
    - b. Release the STOP button, then release the OPEN and CLOSE buttons.

This procedure will work with the Cal Pod (keypad) in either CAL or RUN mode.

This procedure was specifically designed to prevent the accidental altering of a limit through normal use or a faulty button or wiring.



## Setting Limit Overrun

**▲ WARNING:** The Limit Overrun will override external reversing devices, including photocells and sensing edges or reversing edges. Therefore, any externally connected devices will be disabled during that portion of the door travel controlled by the Limit Overrun function.

The Down Limit Overrun function should be used to close the door no more than the final 2".

**▲ AVERTISSEMENT:** La fonction de dépassement de limite annulera les dispositifs de renversement externes, y compris les cellules photoélectriques et des systèmes de détection ou d'inversion aux bords. En conséquence, tous les dispositifs externes connectés seront désactivés pendant la partie de la course de la porte qui est contrôlée par la fonction de dépassement de limite.

La fonction de dépassement de limite inférieure doit être utilisée pour fermer la porte uniquement aux derniers 5 cm.

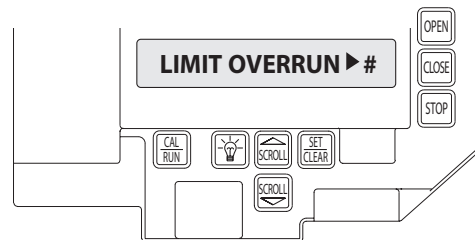
- A)** The Limit Overrun setting is a matter of trial and error. The goal is to adjust the Limit Overrun until an appropriate seal is obtained between the bottom edge of the door and the floor.
- B)** The Limit Overrun setting can be varied between 0 and 9. 0 - disables the Limit Overrun so that the door stops at the down limit switch setting. 9 - causes the greatest amount of door travel beyond the limit switch setting. Door should close gently with light tension on door cables, or minimal stacking on rolling steel slats.
- 1) Press CAL-RUN to enter calibration mode
  - 2) Press scroll (DN) until the display reads "LIMIT OVERRUN>(0-9)." **Fig. 9.**

- 3) Press SET/CLEAR until the display reads the desired value.
- 4) Press the OPEN key to open the door a few feet, then release
- 5) Press the CLOSE key to close the door and hold until the operator stops.
- 6) Check the door seal and repeat steps 3-5 until the appropriate seal is obtained between the door and the floor.

**▲ CAUTION:** If proper seal cannot be obtained at a setting of 9, Reset the Limit Overrun back to 0 and reset the Down Limit position as described on 6.4. Then adjust the Limit Overrun as instructed above.

**▲ ATTENTION:** Si une adhésion appropriée ne peut être obtenue à un réglage de 9, réinitialiser le dépassement de limite à 0 puis la position de déplacement de la limite inférieure selon les instructions de la page 6.4. Régler ensuite le dépassement de limite tel qu'indiqué ci-dessus.








- 7) Press CAL-RUN to return to Run mode.










**Figure 9**

## Setting Open and Close Modes (Constant vs Momentary Contact)

### OPEN

- 1) If operator is in RUN mode, press CAL/RUN  to enter calibration mode.
- 2) Press SCROLL  until display reads "OPEN MODE>MOM" or "OPEN MODE>C-STP." **Figure 10.**
  - MOM=momentary contact, meaning you **press and release** the OPEN  or CLOSE  key and **the door will continue to move** until it reaches its travel limit. (See NOTE)
  - C-STP=constant contact-stop, meaning **if you release the key** prior to the door reaching its travel limit, **the door will stop.**
- 3) Press SET/CLEAR  key to toggle between "OPEN MODE>C-STP" or "OPEN MODE>MOM" on the display.
- 4) Press a SCROLL  key to shift to a new function and lock in the setting.
- 5) Press CAL/RUN  to return to run mode.

### CLOSE

- 1) If operator is in RUN mode, press CAL/RUN  to enter calibration mode.
- 2) Press SCROLL  until display reads "CLOSE MODE>MOM," "CLOSE MODE>C-STP" or "CLOSE MODE>C-REV." **Figure 10.**
  - MOM=momentary contact, meaning you **press and release** the OPEN  or CLOSE  key and **the door will continue to move** until it reaches its travel limit. (See NOTE)
  - C-STP=constant contact-stop, meaning **if you release the key** prior to the door reaching its travel limit, **the door will stop.**
  - C-REV=constant contact-reverse, meaning **if you release the key** prior to the door reaching its travel limit, **the door will reverse direction.** (See NOTE)
- 3) Press SET/CLEAR  key to toggle between "CLOSE MODE>C-STP" or "CLOSE MODE>C-REV" or "CLOSE MODE>MOM" on the display.
- 4) Press a SCROLL  key to shift to a new function and lock in the setting.
- 5) Press CAL/RUN  to return to run mode.

**NOTE:** Momentary contact (**MOM**) or Constant Reverse (**C-REV**) may not be used unless both the OPEN and CLOSE Limits have been set.

In situations where an external reversing device is either not installed or not operating properly, Constant Contact (**C-STP**) **MUST BE USED.**

**⚠ WARNING:** Before momentary contact control can be used on the CLOSE button, a monitored external reversing device such as a photocell system or sensing edge switch must be used. See pages 5.7-5.9 for installation of entrapment protection devices.

**⚠ AVERTISSEMENT:** Avant d'utiliser la commande à contact momentané sur le bouton FERMETURE, un dispositif d'inversion externe surveillée tel qu'un système de cellule photoélectrique ou un commutateur de détection de bord doit être utilisé. Voir l'installation des dispositifs de protection contre le coincement en pages 5.7-5.9.

**NOTE:** During adjustment of a Travel Limit, the Open and Close Modes will automatically fail-safe to Constant Contact until the Limit has been set or reset. At that time the Open and Close Modes will revert to their previous setting.

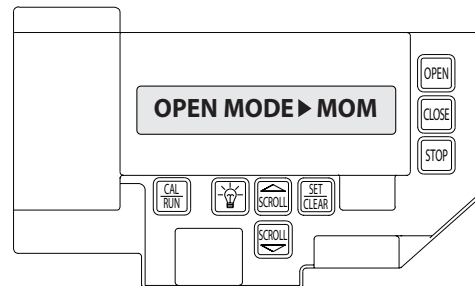







Figure 10

## (Optional) Transmitter Programming



### Adding a Transmitter

- 1) If operator is in RUN mode, press CAL/RUN  to enter calibration mode.
- 2) Press SCROLL  (up or down) until display reads "LEARN NEW XMTR? "

#### Figure 11.

- This question along with the instruction "HIT SET FOR YES" will continuously pan across the display window. (Pressing SCROLL or RUN/CAL will cancel the operation.)
- 3) Press SET .
  - Display will read "PUSH XMTR BUTTON TWO TIMES TO LEARN XMTR."
  - 4) Press Transmitter button two times.
    - The display will read "XMTR \_\_\_LEARNED." Where it assigns a random number between 1 and 255 to the transmitter. That transmitter is entered and ready to operate the door. (Label/mark the transmitter.)
  - 5) Press SCROLL  (up or down) to move on to another menu item, or CAL/RUN  to exit the CAL mode.

### Removing Individual Transmitter

- 1) If operator is in RUN mode, press CAL/RUN  to enter calibration mode.
- 2) Press SCROLL  (up or down) until display reads "REMOVE XMTR? "

#### Figure 12.






- This question along with the instruction "HIT SET FOR YES" will continuously pan across the display window. (Pressing SCROLL or CAL/RUN will cancel the operation.)
- 3) Press SET .
  - A menu displaying the available transmitter numbers will appear. Press SCROLL  (up or down) to cycle through the menu to the number of the transmitter to be removed. (Pressing CAL/RUN will cancel the operation.)
  - 4) Press SET .
  - The transmitter is removed.
  - 5) Press SCROLL  (up or down) to move on to another menu item, or CAL/RUN  to exit the CAL mode.



Figure 11

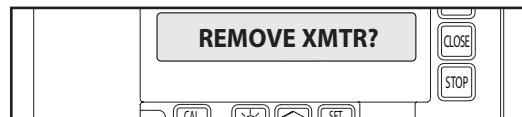








Figure 12



Figure 13




### Removing All Transmitters

- 1) If operator is in RUN mode, press CAL/RUN  to enter calibration mode.
- 2) Press SCROLL  (up or down) until display reads "REMOVE ALL XMTRS" **Figure 13.**
  - This question along with the instruction "HIT SET FOR YES" will continuously pan across the display window. (Pressing SCROLL or CAL/RUN will cancel the operation.)
- 3) Press the SET  key.
  - The display will read "ARE YOU SURE."
- 4) Press the SET  key.
  - All transmitters are removed.
- 5) Press SCROLL  (up or down) to move on to another menu item, or CAL/RUN  to exit the cal mode.




## Optional Mid-Stop Limit Setting

The *RHX*® Operator includes a programmable Mid-Stop. This feature allows the operator to stop at a user selectable point when opening. It is used when operating very tall doors that only open to their full height occasionally. The Mid-Stop does not effect the operator when closing. To operate door to full open position from mid-stop, press open button again.





**NOTE:** Setting of the MID-STOP should only be performed AFTER Travel Limits have been set and door has been cycled fully open and then fully closed.

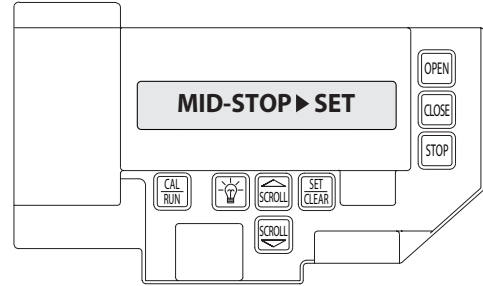
- 1) Press CAL/RUN  to enter calibration mode.
- 2) Press the CLOSE  to close the door to the down limit.
- 3) Press SCROLL  until display reads "MID-STOP >CLR" **Figure 14**.

**NOTE:** If the display reads MID-STOP > SET at this point, first clear the MID-STOP as described below then repeat steps 1-3 and continue.

- 4) Press the OPEN  to open the door to desired mid-stop height.
- 5) Press SET/CLEAR  until the display reads "MID-STOP > SET"
- 6) Press CAL/RUN  to return to run mode.

To CLEAR the Limit





- 7) Press CAL/RUN  to enter calibration mode.
- 8) Press SCROLL  until display reads "MID-STOP >SET"
- 9) Press SET/CLEAR  until the display reads "MID-STOP > CLR"
- 10) Press CAL/RUN  to return to run mode.



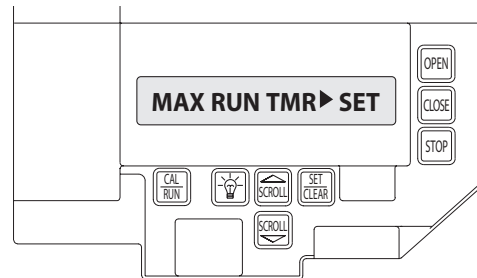
**Figure 14**

**Resetting the MRT** *(The Max Run Timer is set automatically once the unit is cycled between Limits. The Max Run Timer prevents the unit from running continuously in the event of a problem. The MRT's are set to the time required to run from one limit to the other, plus 5 seconds (nominal). When the MRT is exceeded, the operator stops and will not respond to any command until it is reset by pressing one of the calibration keys or by cycling power to the unit.)*

#### TO RESET

- 1) Press CAL/RUN  to enter calibration mode.
- 2) Press SCROLL  (up or down) until display reads "MAX RUN TMR > SET." **Figure 15.**
- 3) Press SET/CLEAR  until display reads "MAX RUN TMR > CLR."
- 4) Press CAL/RUN  to return to RUN mode.
- 5) Cycle the door between limits.

**NOTE: The Max Run Timer must be reset each and every time the Travel Limits are adjusted.**








**Figure 15**

**⚠ CAUTION:** The MID-STOP feature must be turned off in order to properly set the Max Run Timer.

**⚠ ATTENTION:** La fonction MID-STOP doit être désactivée afin de régler correctement la minuterie de course maximum.

## Monitored Reversing Devices

### ODC Safe-T-Beams® (OPTIONAL)

- 1) If operator is in RUN mode, press CAL/RUN  to enter calibration mode.
- 2) Press SCROLL  (up or down) until display reads "ODC STB>ON" or "ODC STB>OFF" **Figure 16**.
- 3) Press SET/CLEAR  key to toggle between ON and OFF.
- 4) Press SCROLL  (up or down) to shift to a new function and lock setting.
- 5) Press CAL/RUN  to return to run mode.

**NOTE:** Installation of Series II Monitored Photocells DOES NOT make the unit legal for residential use. The Overhead Door® Company strictly prohibits any installation of a commercial unit in any residentially zoned construction.

**⚠ WARNING:** Photocell systems provide entrapment protection when mounted near the doorway in such a way that the lower portion of an individual's leg will break the photocell beam during normal walking through the doorway.

**⚠ AVERTISSEMENT:** Les systèmes de cellules photoélectriques fournissent une protection contre le coincement s'ils sont installés à proximité de la porte de manière à ce que la partie inférieure de la jambe d'un individu puisse rompre le faisceau de la cellule photoélectrique lors de passages normaux par la porte.

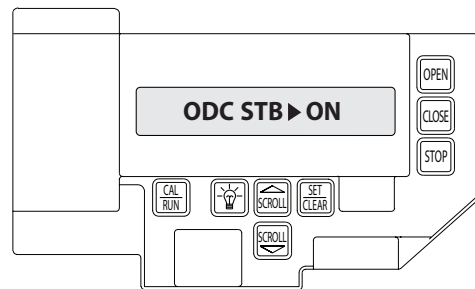





Figure 16

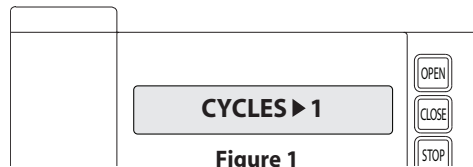
## Current UL Approved Monitored Reversing Devices

- 1) MillerEdge ME and MT series monitored edge sensors used in combination with Timer-Close Module P/N OPABTCX.S.
- 2) MillerEdge ME and MT series monitored edge sensors used in combination with MillerEdge Interface Module OPAKMEIGX.S. (Direct connect through STB inputs).
- 3) MillerEdge Wireless monitored edge sensor OPAKMMWE.S.
- 4) Residential Safe-T-Beam® Monitored Photocells - P/N 37221R (OSTB-BX) and 38176R.S (includes extension brackets)
- 5) Series II Commercial Safe-T-Beam® Monitored Photocells - P/N OPAKPE.S and OPAKPEN4GX.S (NEMA 4).
- 6) Monitored Retro-Reflective Photoeye - P/N OPAKRPEN4X.S




## Section 7: Special Operator Features (No user input)

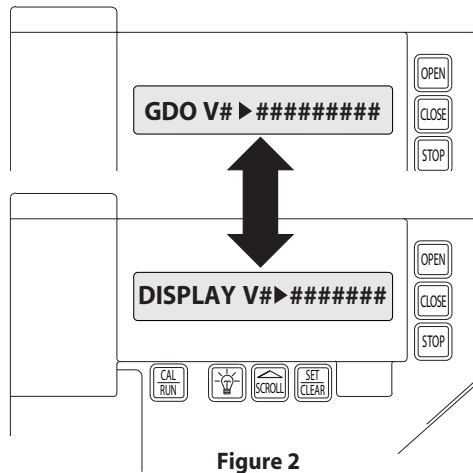
### Operator Cycle Count

- 1) Press CAL/RUN  to enter calibration mode.
- 2) Press SCROLL  until display reads "CYCLES>1,2,3 etc. where the number is the number of open/close cycles the operator has performed. **Figure 1**.
- 3) Press CAL/RUN  to return to run mode.



### GDO and Display Firmware





- 1) Press CAL/RUN  to enter calibration mode.
- 2) Press SCROLL  until display reads "GDO V# > #####." **Figure 2**. This display will cycle between the version number of the current GDO firmware and the current Display Firmware.
- 3) Press CAL/RUN  to return to run mode.

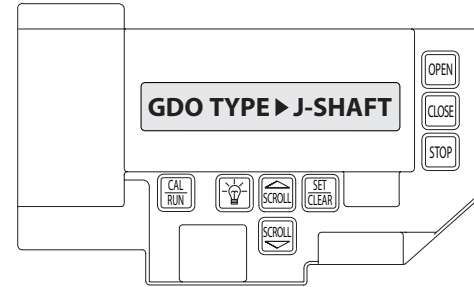


## Operator Type Fig. 3

*These operators are available for use in jackshaft or trolley configurations. The same control board is used for either configuration, however the control board must be set for the appropriate GDO configuration. A board set for trolley mode will not work in a jackshaft operator and vice-versa.*

**NOTE:** The GDO type is factory set. The installer should not have to set this feature. However, if the GDO type is inadvertently changed, or if a board needs to be replaced in the field, follow these instructions to set GDO type.

- 1) Press CAL/RUN  to enter calibration mode.
- 2) Press SCROLL  until display reads "GDO TYPE > ."  
This will display the current GDO type.
- 3) Press SET/CLEAR  until display indicates correct GDO type ( J-SHAFT or TROLLEY)
- 4) Press CAL/RUN  to return to run mode.



**Figure 3**



# Section 8: Troubleshooting

## Display Operation in Run Mode

These operators display their status on the LCD display. Each time the operator runs, stops, reverses or refuses to run, the display will indicate why the action did, or did not, take place.

Once an error code has been generated, the operator will continue to display the error code while the operator is not running. This error code can be cleared by pressing the STOP button or STOP key on the keypad. The error code will automatically clear when the operator stops at the down limit. Error codes will continue to be stored in the operator's Error Code Memory after they have been cleared from the display in the Run Mode.

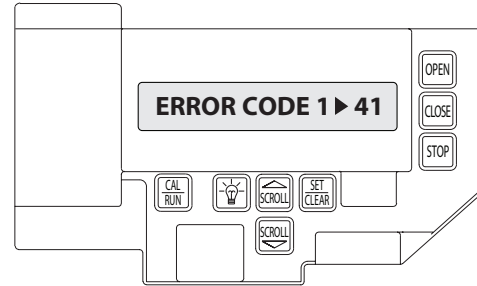


Figure 1

## Error Codes

To aid in troubleshooting problems, these operators include an error code memory that stores the last 10 error events. These codes are stored with or without power. The last error code detected is also displayed on the LCD until the stop button or key is pressed or the operator stops at the down limit.

The error code memory stores the last 10 error codes in sequence. Once 10 codes are stored, the oldest code is erased to make room for the newest code. These codes are displayed in calibration mode. The display will flash the number of the error code and the 2-digit error code followed by a description of the error code. **Fig. 1 & 2.**

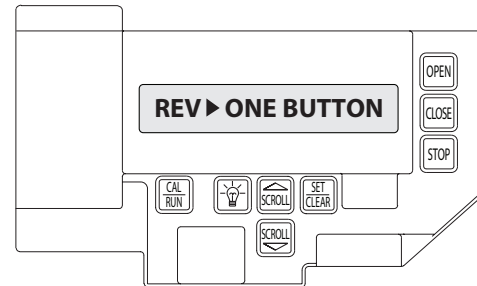






Figure 2

## Error Codes (continued)

### To view the error code memory

- 1) Press CAL/RUN  to enter calibration mode.
- 2) Press SCROLL  until display reads "ERROR CODE 1 >".
  - The display will begin flashing the error code number and 2-digit error code followed by its description.
  - Reminder: Error code number 1 is the latest code generated.
- 3) Press SET/CLEAR . The display will now read "ERROR CODE 2 > ." (This is the error code which was generated before error code 1.)
- 4) Repeat step 3 until all 10 error codes have been displayed or move on to step 5 when ready.
- 5) Press CAL/RUN  to return to run mode.

**NOTE:** For all error codes see Appendix C, Sections 10.10 - 10.11.

## Run Codes

The operators also include a run code memory that stores the last 10 run events. These codes are stored with or without power. Each time the operator runs or stops, it generates a code that it stores in this memory (Why the operator ran or stopped). Used together with the error code memory, it becomes a powerful troubleshooting aid.

The run code memory stores the last 10 codes in sequence. Once 10 codes are stored, the oldest code is erased to make room for the newest code. These codes are displayed in calibration mode. The display will flash the number of the run code and the 2-digit run code followed by a description of the run code. **Fig. 3 & 4.**

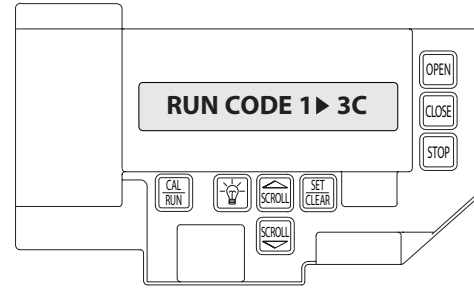


Figure 3

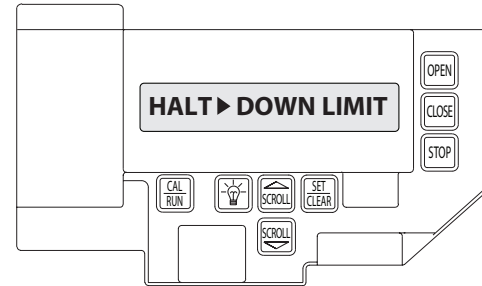






Figure 4

## Run Codes (continued)

### To view the run code memory:

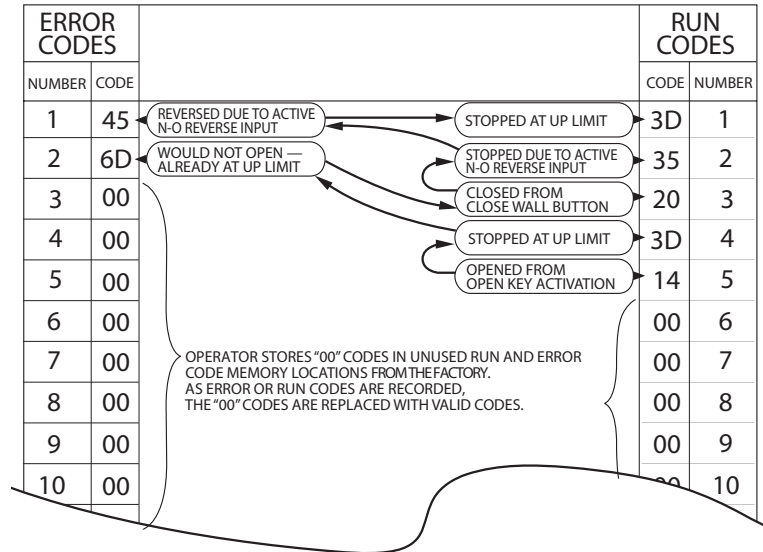
- 1) Press CAL/RUN  to enter calibration mode.
- 2) Press SCROLL  until display reads "RUN CODE 1 > ."  
  - The display will begin flashing the run code number and code followed by its description.
  - Remember: run code number 1 is the latest code generated.
- 3) Press SET/CLEAR . The display will now read "RUN CODE 2 > ."  
 (This is the run code which was generated before run code 1.)
- 4) Repeat step 3 until all 10 run codes have been displayed or move on to step 5 when ready.
- 5) Press CAL/RUN  to return to run mode.

**NOTE:** For all run codes see Appendix C, Section 10.9.

### TROUBLESHOOTING EXAMPLE USING RUN AND ERROR CODE MEMORIES. Fig. 5

1. In Calibration Mode, display and write down each Run Code and Error Code stored in memory.
2. List as shown in Fig. 5.
3. Refer to Appendix C to interpret the codes.

In this example, the operator was opened using the OPEN key on the keypad and stopped at the up limit. The OPEN wall button was then activated, causing the "6D" code to be generated since the operator could not open when it is already at the up limit. The CLOSE wall button was then activated, causing the operator to close. While closing, the Normally-Open (N-O) Reverse Input was activated, causing the operator to stop and then reverse, stopping at the up limit.

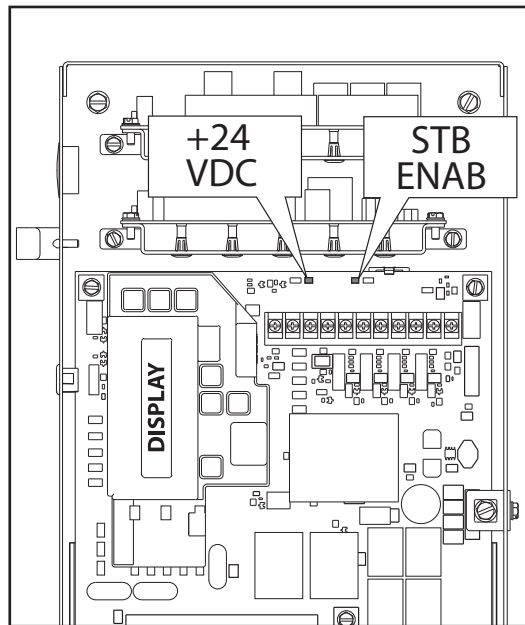


**Figure 5**

## LED Indicators Fig. 6

RHX® operators include a self-diagnostic circuit board using troubleshooting LED indicators to signal the technician of a problem.

Figure 6



### TROUBLESHOOTING LED's

STB ENABLE	NORMALLY ON - STB ENABLED	OFF - STB DISABLED
+ 24 VOLTS DC	NORMALLY ON - POWER AVAILABLE	OFF - CHECK AC POWER SUPPLY CHECK FUSES

## Safe-T-Beam® Monitored Photocell Self-diagnostic Troubleshooting Chart

SOURCE (RED LED)	SENSOR (GREEN LED)	INDICATED CONDITION	REQUIRED ACTION
● ON	● ON	NORMAL OPERATION	NONE REQUIRED
○ OFF	○ OFF	1. POWER HEAD NOT POWERED 2. WIRING FROM POWER HEAD BAD	1. CHECK BREAKERS, FUSES, PLUGS 2. CHECK WIRING FOR OBVIOUS SHORTS
○ OFF	● ON	1. WIRING TO SOURCE MISSING OR BAD 2. POWER HAS BEEN INTERRUPTED	1. CHECK WIRING 2. REMOVE POWER AND REAPPLY
2 BLINKS, PAUSE (REPEAT)	● ON	1. BEAM NOT ALIGNED 2. BEAM OBSTRUCTED 3. SENSOR DEFECTIVE	1. CHECK ALIGNMENT 2. CHECK FOR OBSTRUCTION 3. CALL CUSTOMER SERVICE
2 BLINKS, PAUSE (REPEAT)	○ OFF	1. WIRE TO SENSOR MISSING OR BAD 2. SENSOR DEFECTIVE	1. CHECK WIRING 2. CALL CUSTOMER SERVICE
3 BLINKS, PAUSE (REPEAT)	● ON	1. SENSOR RECEIVING INTERFERENCE	1. ATTEMPT TO DETERMINE SOURCE OF INTERFERENCE 2. CALL CUSTOMER SERVICE
4 BLINKS, PAUSE (REPEAT)	● ON	1. SOURCE NOT SENDING PULSES 2. SOURCE DEFECTIVE	1. CALL CUSTOMER SERVICE 2. CALL CUSTOMER SERVICE

**⚠ WARNING:** ACTUATING THE OPERATOR BY USING CONSTANT CONTACT ON THE CLOSE BUTTON WILL OVERRIDE NON-FUNCTIONING EXTERNAL REVERSING DEVICES, INCLUDING PHOTOCELLS.

**⚠ AVERTISSEMENT:** L'ACTIVATION DE L'OPERATEUR EN UTILISANT UN CONTACT CONSTANT SUR LE BOUTON FERMER ANNULERA LES DISPOSITIFS D'INVERSIONS EXTERNES, Y COMPRIS LES CELLULES PHOTOELECTRIQUES.

**⚠ WARNING:** Overhead Door Corporation recommends that line voltage wiring be performed by qualified electrician. See Section 5 for additional wiring instructions.

**⚠ AVERTISSEMENT:** Overhead Door Corporation recommande que le câblage au secteur soit effectué par un électricien qualifié. Voir la section 5 pour des instructions supplémentaires sur le câblage.

## Section 9: Service and Maintenance

### Maintenance Schedule

The following table provides a schedule of recommended Service and Maintenance items to be completed by a trained service representative.

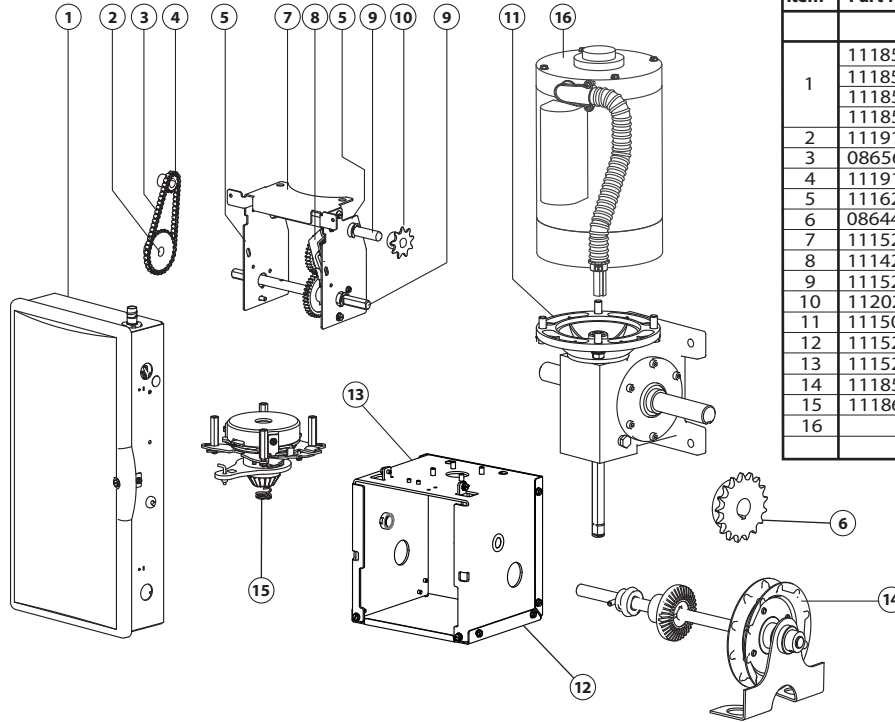
**⚠ CAUTION:** Failure to perform the recommended Service & Maintenance may result in premature failure of the operator.

**⚠ ATTENTION:** Si les instructions de service et de maintenance recommandés ne sont pas suivies, l'opérateur pourrait tomber en panne prématurément.

SERVICE ITEM	SERVICE INTERVAL (FREQUENCY)			
	MONTHLY	EVERY 6 MO. OR 5,000 CYCLES	EVERY 12 MO. OR 10,000 CYCLES	EVERY 36 MO. OR 30,000 CYCLE
MANUAL OPERATION OF DOOR		●		
PHOTOCELL/ SENSING EDGE OPERATION	●			
CLUTCH (OPTIONAL) ADJUSTMENT			●	
CHECK FOR LOSE OR MISSING HARDWARE			●	
CHECK LIMIT POSITION				●
GEAR TRAIN WEAR				●

# Section 10: Appendix A

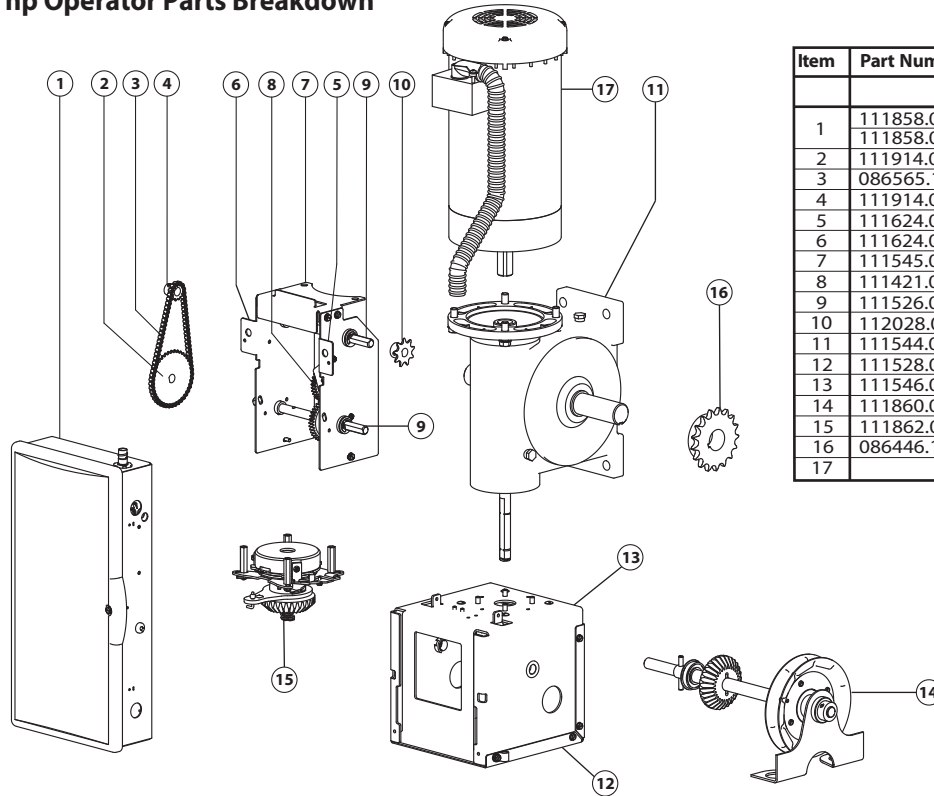
## 1/2 & 1 hp Operator Parts Breakdown



Item	Part Number	Description	Qty
<b>OPER ASSY, 1/2 &amp; 1 HP, RHXH, FIREKING</b>			
1	111858.0001	ELEC BOX, 1/2HP, 1PH	1
	111858.0003	ELEC BOX, 1HP, 1PH	
	111858.0005	ELEC BOX, 3PH	
	111858.0006	ELEC BOX, 575V	
2	111914.0002	SPRKT, #25, 28T, 1/4P, .501 D-BORE	1
3	086565.1033	CHAIN, RLR, #25 X 50P, LOOP	1
4	111914.0001	SPRKT, #25, 12T, 1/4P	1
5	111625.0001	COVER, LIMIT	2
6	086446.1716	SPRKT, #50, 17T, 1" BORE	1
7	111525.0001	ENCL, LIMIT, HXH	1
8	111421.0003	LIMIT MODULE	1
9	111526.0001	SHAFT, LIMIT	2
10	112028.0001	SPRKT, 9T, 1/2P, #410	1
11	111503.0002	GEAR REDUCER, 1/2-1 HP	1
12	111528.0001	COVER, BRAKE/RELEASE	1
13	111527.0001	ENCLOSURE, BRAKE	1
14	111859.0001	SHAFT ASSY, HOIST, HXH	1
15	111861.0001	BRAKE/RELEASE ASSY, 1/2 & 1HP	1
16		MOTOR (SEE PAGE 10.5)	1

# Appendix A (continued)

## 3 hp Operator Parts Breakdown

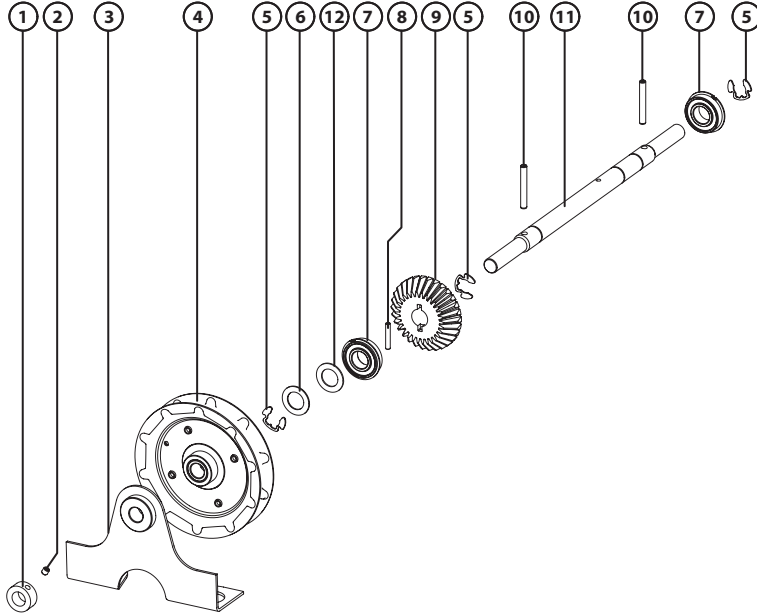


Item	Part Number	Description	Qty
		<b>OPER ASSY, 3 HP, RHXH, FIREKING</b>	
1	111858.0005	ELEC BOX, 3PH	1
	111858.0006	ELEC BOX, 575V	
2	111914.0004	SPRKT, #25, 40T, 1/4P, .501 D-BORE	1
3	086565.1028	CHAIN, RLR, #25 X 68P, LOOP	1
4	111914.0001	SPRKT, #25, 12T, 1/4P	1
5	111624.0001	COVER, LIMIT, 3HP, LH	1
6	111624.0002	COVER, LIMIT, 3HP, RH	1
7	111545.0001	ENCL, LIMIT, HXH, 3HP	1
8	111421.0003	LIMIT MODULE	1
9	111526.0001	SHAFT, LIMIT	2
10	112028.0001	SPRKT, 9T, 1/2P, #410	1
11	111544.0001	GEAR REDUCER, 3 HP	1
12	111528.0001	COVER, BRAKE/RELEASE	1
13	111546.0001	ENCLOSURE, BRAKE, 3HP	1
14	111860.0001	SHAFT ASSY, HOIST, HXH, 3HP	1
15	111862.0001	BRAKE/RELEASE ASSY, 3HP	1
16	086446.1720	SPRKT, #50, 17T, 1-1/4 BORE	1
17		MOTOR (SEE PAGE 10.5)	1



# Appendix A (cont')

## Basic Hoist Shaft Repair Parts

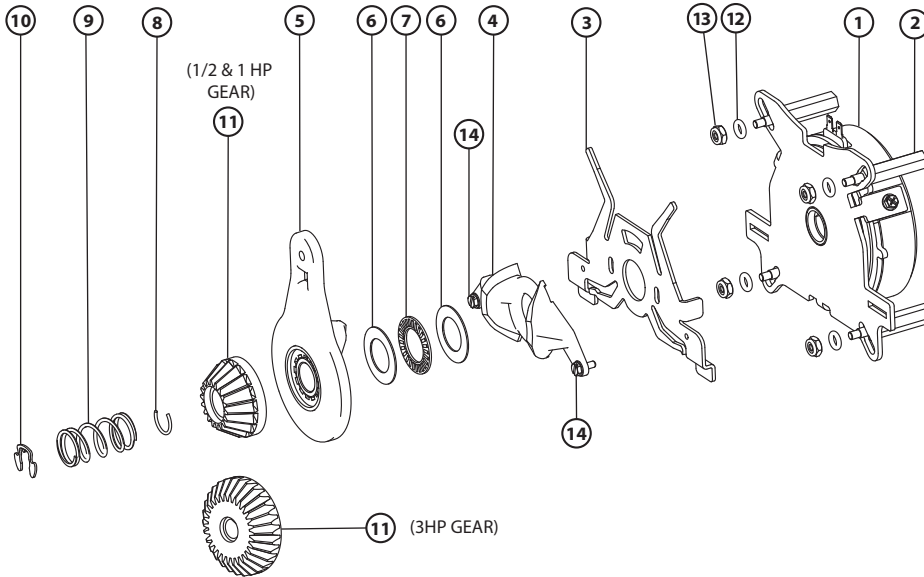


Item	Part Number	Description	Qty
	<b>111859.0001</b>	<b>SHAFT ASSY, HOIST, HX, 1/2 &amp; 1HP</b>	
1	604297.3062	SET COLLAR, 5/8"ID X 1-1/8" OD	1
2	080300.1604	SCR, SET, KNRLD, 1/4-20 X 1/4	1
3	110411.0001	CHAIN GUARD ASSY	1
4	110872.0001	HANDWHEEL, STANDARD CHAIN	1
5	111382.0003	RING, RTNG, HIGH GRIP, .50	3
6	110819.0001	WASHER, PLAIN, .651 ID	1
7	110813.0001	BEARING, .625 ID	2
8	110881.0001	PIN, DOWEL, .188 X 1	1
9	111531.0002	GEAR, BEVEL, 36T	1
10	110313.0010	PIN, SPRING, .250 DIA X 2.00	2
11	111529.0001	SHAFT, HOIST, HX	1
12	086649.0029	WASHER, THRUST, .64	1

Item	Part Number	Description	Qty
	<b>111860.0001</b>	<b>SHAFT ASSY, HOIST, HX, 3HP</b>	
1	604297.3062	SET COLLAR, 5/8"ID X 1-1/8" OD	1
2	080300.1604	SCR, SET, KNRLD, 1/4-20 X 1/4	1
3	110411.0001	CHAIN GUARD ASSY	1
4	110872.0001	HANDWHEEL, STANDARD CHAIN	1
5	111382.0001	RING, RTNG, HIGH GRIP	3
6	110819.0003	WASHER, PLAIN, .770 ID	1
7	110695.0001	BEARING, .75 ID	2
8	110881.0001	PIN, DOWEL, .188 X 1	1
9	111552.0001	GEAR, BEVEL, 30T	1
10	110313.0010	PIN, SPRING, .250 DIA X 2.00	2
11	111554.0001	SHAFT, HOIST, HX, 3HP	1
12	086649.0030	WASHER, THRUST, .765	1

# Appendix A (cont')

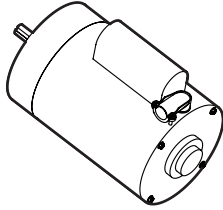
## Brake/Release Enclosure Repair Parts



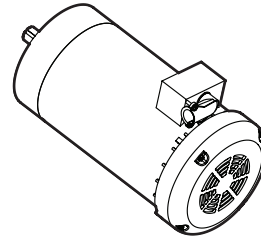
Item	Part Number	Description	Qty
	<b>111861.0001</b>	<b>BRAKE/RELEASE, 1/2 &amp; 1HP</b>	
	<b>111862.0001</b>	<b>BRAKE/RELEASE, 3 HP</b>	
1	112245.0002	BRAKE ASSY	1
2	111512.0001	#8-32 HEX STANDOFF	4
3	112243.0001	RELEASE BRKT	1
4	111534.0001	RAMP, LIFTING, RELEASE	1
5	111599.0001	RELEASE ARM	1
6	111403.0001	WASHER, THRUST	2
7	111402.0001	BEARING, THRUST	1
8	111600.0001	RING	1
9	112389.0001	SPRING, .796 OD	1
10	111382.0002	RTNG RING, .406 DIA	1
11	111539.0001	GEAR, 18T (1/2 & 1HP)	1
	111553.0001	GEAR, 30T (3 HP)	1
12	111346.0001	O-RING, SIZE 107	4
13	601108.0005	NUT, LK, HEX, #8-32	4
14	24173F04	SCR, #6-32 X 3/8	2

# Appendix A (continued)

## Motor Options (UL Approved)



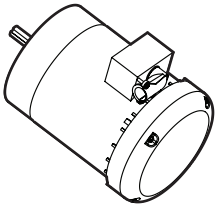
111502.0001—1/2HP, 1 PH, ODP  
111502.0003—1HP, 1 PH, OPD  
111502.0004—1/2HP, 3 PH, OPD  
111502.0006—1HP, 3 PH, OPD  
111502.0007—1/2HP, 575V, OPD  
111502.0009—1HP, 575V, OPD



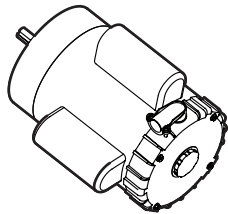
111548.0001—3HP, 3 PH, TEFC  
111548.0002—3HP, 575V, TEFC

---

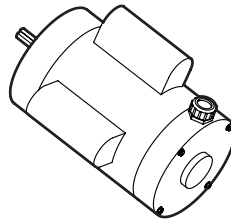
## Motor Options (Not UL Approved)



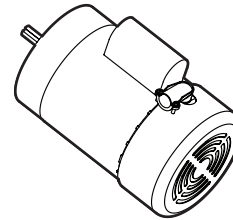
111695.0001—1/2HP, 3 PH, TEFC  
111695.0002—1HP, 3 PH, TEFC  
111695.0003—1HP, 575V, TEFC



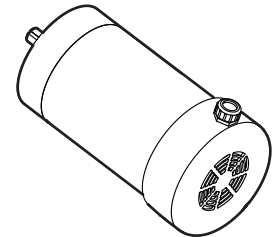
111696.0001—1/2HP, 1 PH, TENV  
111696.0002—1/2HP, 3 PH, TENV  
111696.0003—1HP, 3 PH, TENV  
111696.0004—1HP, 575V, TENV



111697.0001—1/2HP, 1 PH, N4  
111697.0002—1HP, 1 PH, N4  
111697.0003—1/2HP, 3 PH, N4  
111697.0004—1HP, 3 PH, N4  
111697.0004—1HP, 575V, N4



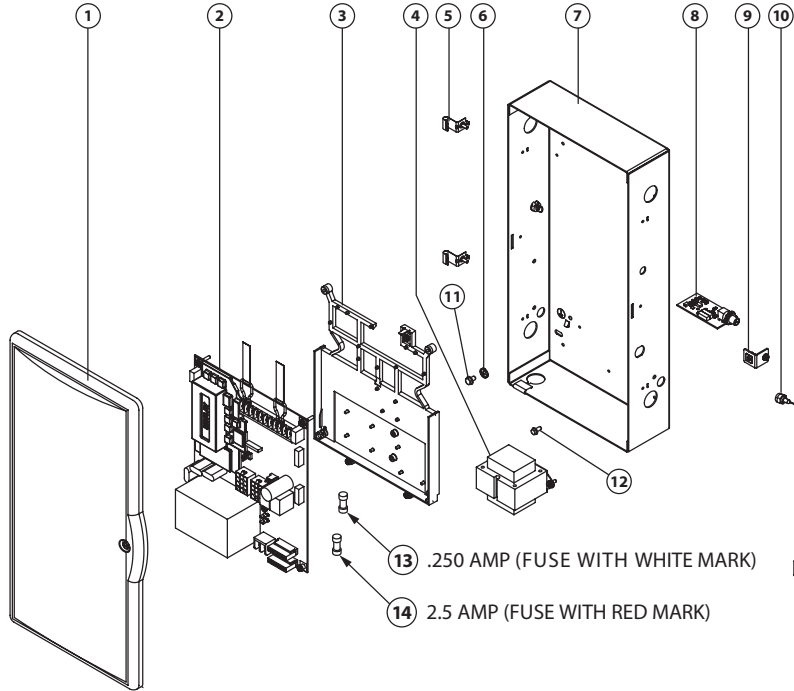
111694.0001—1/2HP, 1 PH, TEFC  
111694.0002—1HP, 1 PH, TEFC



111698.0001—3HP, 3 PH, N4  
111698.0002—3HP, 575V, N4

# Appendix A (cont')

## Base Electric Box Parts

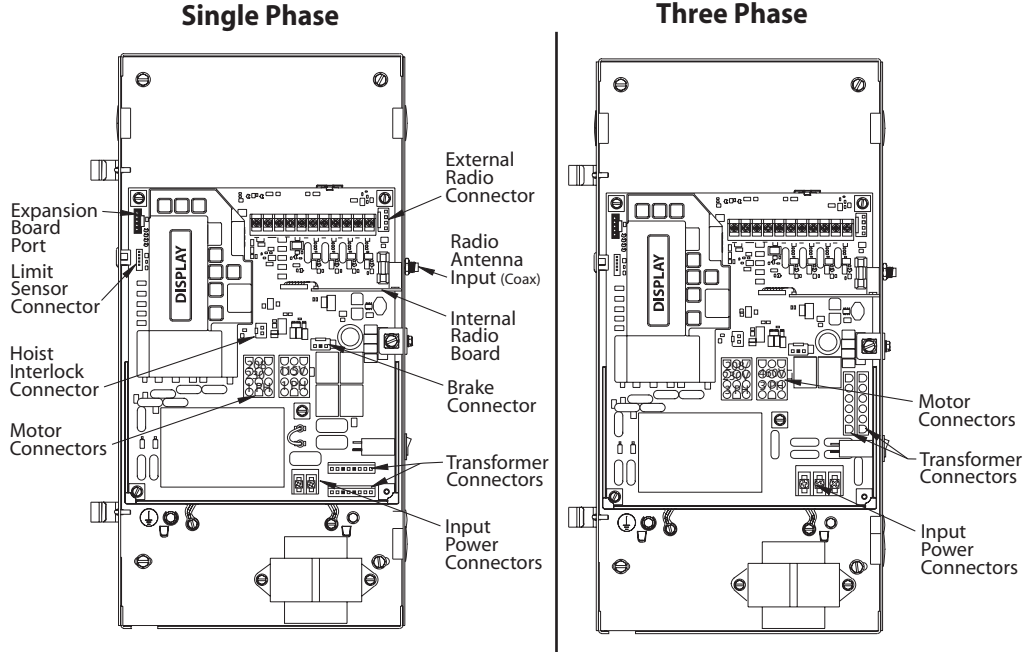


Item	Part Number	Description	Qty
1	111853.0001	COVER ASSY, 1 PHASE	1
	111853.0002	COVER ASSY, 3 PHASE	
	111853.0003	COVER ASSY, 575V	
2	111854.0001	CIRCUIT BOARD ASSY, 1 PHASE, 1/2 HP	1
	111854.0002	CIRCUIT BOARD ASSY, 1 PHASE, 3/4 - 1HP	
	111854.0004	CIRCUIT BOARD ASSY, 3 PHASE	
	111854.0005	CIRCUIT BOARD ASSY, 575V	
3	111401.0001	INSULATOR BOARD ASSY	1
4	111087.0001	XFMR, 115/208/230V, 1 PHASE	1
	111087.0002	XFMR, 208/230/460V, 3 PHASE	
	111087.0003	XFMR, 575V	
5	110950.0001	HINGE ASSY	2
6	22634A	WASHER, CUP	1
7	110630.0001	ELECTRIC BOX	1
8	111397.0001	RECEIVER ASSY	1
9	111398.0001	LATCH ASSY	1
10	111352.0001	ANTENNA ASSY	1
11	8706F29	SCREW, GROUND, #10-32 X 3/8	1
12	8706E29	SCREW, GROUND, #8-32 X 3/8	1
13	34004DR250	FUSE, .250A, SLOW BLOW	1
14	34004C02R5	FUSE, 2.5A, FAST ACTING	1
NS	111405.0001	SPARE FUSE KIT	
NS	110100.0015	CIRCUIT BREAKER, 1 HP, 1 PHASE	

NS=NOT SHOWN

# Appendix A (cont')

## Basic Electric Box Layout



# Section 10: Appendix B

## Screw Terminal Assignments

INPUT	FUNCTION	CONNECTION TYPE	
<b>11-POSITION TERMINAL BLOCK</b> INSIDE ELECTRIC BOX	OPEN	Causes door to open if not at Up Limit. Causes a closing door to reverse.	Normally-Open Dry Contact to GND.
	CLOSE	Causes door to close if not at Down Limit.	Normally-Open Dry Contact to GND.
	STOP	Causes a moving door to stop. Prevents the operator from running.	Normally-Closed Dry Contact to GND.
	GND	Common ground connection for Open, Close, Stop & 1-Btn Inputs.	
	1-BTN	Causes door to open if not at Up Limit or Mid-Stop Limit. Causes door to close if at Up Limit or Mid-Stop Limit. Causes door to stop if opening. Causes a closing door to reverse.	Normally-Open Dry Contact to GND.
	ODC STB	Reverses a closing door if photocell beam is blocked. NOTE: STB's must be enabled in Calibration Mode.	ODC Series II Safe-T-Beams® ONLY to these inputs. (not polarity sensitive)
	ODC STB	Reverses a closing door if photocell beam is blocked. NOTE: STB's must be enabled in Calibration Mode.	ODC Series II Safe-T-Beams® ONLY to these inputs. (not polarity sensitive)
	N-O REVERSE	Causes a closing door to reverse. NOTE: Will not open a stopped door.	Normally-Open 2-Wire Non-Monitored Edge Sensor. (not polarity sensitive)
	N-O REVERSE	Causes a closing door to reverse. NOTE: Will not open a stopped door.	Normally-Open 2-Wire Non-Monitored Edge Sensor. (not polarity sensitive)
	EXT INTLK	Causes a moving door to stop. Prevents the operator from running when contact is open. Operates even if microcontroller is non-functional.	Normally-Closed dry contacts. (board will energize these contacts at nominal +24VDC).
	EXT INTLK	Causes a moving door to stop. Prevents the operator from running when contact is open. Operates even if microcontroller is non-functional.	Normally-Closed dry contacts. (board will energize these contacts at nominal +24VDC).
<b>2-POS TERMINAL BLOCK</b> <b>1 PHASE</b> (INSIDE ELECTRIC BOX)	L1 / L1	Power to Operator.	120VAC: Connect to Line (Hot) / 240VAC: Connect to Line 1.
	N / L2	Power to Operator.	120VAC: Connect to Neutral / 240VAC: Connect to Line 2.
<b>3-POS TERMINAL BLOCK</b> <b>3 PHASE</b> (INSIDE ELECTRIC BOX)	L1	Power to Operator.	
	L2	Power to Operator.	
	L3	Power to Operator.	
<b>RADIO AND ACCESSORIES PIGTAIL</b>	PWR	Power for radio & other accessories. +20 to +40VDC, fused at 250mA (F1).	Connect to radio or other accessory's power input.
	RAD (Radio Input Control)	Causes door to open if not at Up Limit or Mid-Stop Limit. Causes door to close if at Up Limit or Mid-Stop Limit. Causes a closing door to reverse.	Connect to radio or other accessory's signal (output).
	GND	Common ground connection for PWR and RAD terminals.	Connect to radio or other accessory's ground input.
<b>PLUG CONNECTIONS</b> INSIDE ELECTRIC BOX	EXPANSION PORT	Connects accessory modules to operator.	Accessory Module Ribbon Cable.
	TRANSFORMER	Connects main transformer to control board.	Transformer Plug.
	BRAKE	Connects brake solenoid to control board.	Brake Solenoid Plug.
	MOTOR	Connects motor and capacitor to control board.	Motor Plug.
	HOIST INTLK	Causes moving door to stop. Prevents the operator from running. Operates even if microcontroller is non-functional.	Hoist Interlock Plug or Jumper.
	LIMIT SENSOR	Causes door to stop at top and bottom of normal travel.	Limit Sensor Plug.

# Section 10: Appendix C

## Run Code Displays

Condition Code	DISPLAY	Condition Code Description
0C	IDLE > DOWN LIMIT	<b>STANDING BY AT DOWN LIMIT (NOTE: THIS MESSAGE IS DISPLAYED IF BOTH LIMITS ARE ACTIVE)</b>
0D	IDLE > UP LIMIT	STANDING BY AT UP LIMIT
0E	IDLE > MID STOP	STANDING BY AT MID-STOP LIMIT
0F	IDLE > NO LIMIT	STANDING BY BETWEEN LIMITS
10	<b>OPENING &gt; OPEN BTN</b>	<b>OPENING FROM OPEN BUTTON</b>
11	OPENING > ONE BTN	OPENING FROM 1 BUTTON
12	OPENING > RADIO	OPENING FROM RADIO
13	OPENING > AUX OPEN	OPENING FROM AUXILIARY OPEN INPUT
14	OPENING > OPEN KEY	OPENING FROM KEYPAD OPEN KEY
20	<b>CLOSING &gt; CLOSE PB</b>	<b>CLOSING FROM CLOSE BUTTON</b>
21	CLOSING > ONE BTN	CLOSING FROM 1 BUTTON
22	CLOSING > RADIO	CLOSING FROM RADIO
24	CLOSING > CLOSE KP	CLOSING FROM KEYPAD CLOSE KEY
2A	<b>CLOSING &gt; TCM CLS</b>	<b>CLOSING FROM TIMER CLOSE MODULE</b>
2B	CLOSING > FDM CLS	CLOSING FROM FORE DOOR MODULE
30	<b>HALT &gt; WALL BUTTON</b>	<b>GDO STOPPED BECAUSE STOP OR OPEN BUTTON WAS ACTIVATED, POSSIBLY STARTING A REVERSAL</b>
31	HALT > ONE BUTTON	GDO STOPPED BECAUSE 1 BUTTON WAS ACTIVATED, POSSIBLY STARTING A REVERSAL
32	HALT > RADIO	GDO STOPPED BECAUSE RADIO INPUT WAS ACTIVATED, STARTING A REVERSAL
33	HALT > AUX. OPEN	GDO STOPPED BECAUSE AUXILIARY OPEN INPUT WAS ACTIVATED, STARTING A REVERSAL
34	HALT > KEYPAD KEY	GDO STOPPED BECAUSE KEYPAD STOP OR OPEN KEY WAS ACTIVATED, POSSIBLY STARTING A REVERSAL
35	HALT > N-O SAFETY	GDO STOPPED BECAUSE N-O REVERSING INPUT WAS ACTIVATED, STARTING A REVERSAL
36	HALT > ODC STB	GDO STOPPED BECAUSE ODC STB WAS BLOCKED, STARTING A REVERSAL
37	HALT > N-C SAFETY	GDO STOPPED BECAUSE N-C REVERSING INPUT WAS ACTIVATED, STARTING A REVERSAL
38	HALT > MON. EDGE	GDO STOPPED BECAUSE MONITORED EDGE SENSOR INPUT WAS ACTIVATED, STARTING A REVERSAL
39	HALT > DOOR FORCE	GDO STOPPED BECAUSE THE FORCE REQUIRED TO OPERATE THE DOOR WAS TOO HIGH, POSSIBLY STARTING A REVERSAL
3A	<b>HALT &gt; LOSS OF C/C</b>	<b>GDO STOPPED BECAUSE CONSTANT CONTACT ON CONTROL REMOVED BEFORE REACHING A LIMIT, POSSIBLY STARTING A REVERSAL</b>
3B	HALT > SHUTDOWN	GDO STOPPED BECAUSE THE GDO DETECTED A FAULT SUCH AS AN OPEN INTERLOCK, OVERHEATED MOTOR, ETC.
3C	HALT > DOWN LIMIT	GDO STOPPED BECAUSE IT REACHED THE DOWN LIMIT
3D	HALT > UP LIMIT	GDO STOPPED BECAUSE IT REACHED THE UP LIMIT
3E	HALT > MID STOP	GDO STOPPED BECAUSE IT REACHED THE MID-STOP LIMIT
3F	HALT > MODULE FAIL	GDO STOPPED BECAUSE AN EXPANSION MODULE WAS NOT WORKING PROPERLY
40	<b>REV &gt; OPEN BUTTON</b>	<b>GDO REVERSED BECAUSE THE OPEN BUTTON WAS ACTIVATED</b>
41	REV > ONE BUTTON	GDO REVERSED BECAUSE THE 1 BUTTON WAS ACTIVATED
42	REV > RADIO	GDO REVERSED BECAUSE THE RADIO INPUT WAS ACTIVATED
43	REV > AUX OPEN	GDO REVERSED BECAUSE THE AUXILIARY OPEN INPUT WAS ACTIVATED
44	REV > OPEN KEY	GDO REVERSED BECAUSE THE KEYPAD OPEN KEY WAS ACTIVATED
45	REV > N-O SAFETY	GDO REVERSED BECAUSE THE N-O REVERSING INPUT WAS ACTIVATED

# Appendix C (cont')

## Error Code Displays

Condition Code	DISPLAY	Condition Code Description
46	REV > ODC STB	GDO REVERSED BECAUSE THE ODC STB WAS BLOCKED
47	REV > N-C SAFETY	GDO REVERSED BECAUSE THE N-C REVERSING INPUT WAS ACTIVATED
48	REV > MON. EDGE	GDO REVERSED BECAUSE THE MONITORED EDGE SENSOR WAS ACTIVATED
49	REV > DOOR FORCE	GDO REVERSED BECAUSE THE FORCE REQUIRED TO CLOSE THE DOOR WAS TOO HIGH
<b>4A</b>	<b>REV &gt; LOSS OF C/C</b>	<b>GDO REVERSED BECAUSE CONSTANT CONTACT ON THE CONTROL WAS REMOVED BEFORE REACHING THE DOWN LIMIT</b>
4B	REV > MAX RUN TMR	GDO REVERSED BECAUSE THE CLUTCH SLIPPED OR SOME OTHER FAULT OCCURRED THAT ALLOWED THE GDO TO RUN TOO LONG
4F	REV > EXP MOD FAIL	GDO REVERSED BECAUSE AN EXPANSION MODULE WAS NOT WORKING PROPERLY
<b>50</b>	<b>STOP &gt; HOT MOTOR</b>	<b>GDO STOPPED BECAUSE THE MOTOR WAS OVERHEATED</b>
51	STOP > OPEN MRT	GDO STOPPED BECAUSE THE CLUTCH SLIPPED OR SOME OTHER FAULT OCCURRED THAT ALLOWED THE GDO TO RUN OPEN TOO LONG
52	STOP > CLOSE MRT	GDO STOPPED BECAUSE THE CLUTCH SLIPPED OR SOME OTHER FAULT OCCURRED THAT ALLOWED THE GDO TO RUN DOWN TOO LONG
57	STOP > OPEN INTLK	GDO STOPPED BECAUSE THE HOIST INTERLOCK OR EXTERNAL INTERLOCK IS OPEN
58	STOP > WRONG GDO	GDO STOPPED BECAUSE THE BOARD IS SET FOR JACKSHAFT MODE, BUT INSTALLED IN A TROLLEY OPERATOR
59	STOP > DOOR FORCE	GDO STOPPED BECAUSE THE FORCE REQUIRED TO OPEN THE DOOR WAS TOO HIGH
<b>5A</b>	<b>STOP &gt; WRONG LIMIT</b>	<b>GDO STOPPED BECAUSE THE UP LIMIT ACTIVATED WHEN CLOSING OR THE DOWN LIMIT ACTIVATED WHEN OPENING</b>
5B	STOP > WRONG DIR	GDO STOPPED BECAUSE THE DOOR MOVED IN THE WRONG DIRECTION
5C	STALL > DOWN LIMIT	GDO STOPPED BECAUSE IT COULDN'T LEAVE THE DOWN LIMIT DUE TO A SLIPPING CLUTCH OR OTHER PROBLEM
5D	STALL > UP LIMIT	GDO STOPPED BECAUSE IT COULDN'T LEAVE THE UP LIMIT DUE TO A SLIPPING CLUTCH OR OTHER PROBLEM
5E	STALL > MID-STOP	GDO STOPPED BECAUSE IT COULDN'T LEAVE THE MID-STOP LIMIT DUE TO A SLIPPING CLUTCH OR OTHER PROBLEM
<b>60</b>	<b>CHECK STOP BTN</b>	<b>GDO WON'T RUN BECAUSE THE STOP BUTTON IS ACTIVE</b>
61	TCM DISABLED	TIMER CLOSE WON'T WORK BECAUSE NO SAFETIES ARE ENABLED
62	NO RADIO >> C/C	RADIO INPUT WON'T WORK WITH OPEN OR CLOSE FUNCTION IN CONSTANT CONTACT MODE
63	CHECK AUX OPEN	GDO WON'T CLOSE BECAUSE AUXILIARY OPEN INPUT IS ACTIVE
64	CHECK STOP KEY	GDO WON'T RUN BECAUSE THE KEYPAD STOP KEY IS ACTIVE
65	CHECK N-O SAFETY	GDO WON'T CLOSE BECAUSE THE N-O REVERSING IS ACTIVE
66	CHECK ODC STB	GDO WON'T CLOSE BECAUSE THE ODC STB IS BLOCKED
67	CHECK N-C SAFETY	GDO WON'T CLOSE BECAUSE THE N-C REVERSING INPUT IS ACTIVE
68	CHECK MON. EDGE	GDO WON'T CLOSE BECAUSE THE MONITORED EDGE SENSOR IS ACTIVE
69	OVERHEATED MOTOR	GDO WON'T RUN BECAUSE THE MOTOR IS OVERHEATED
<b>6A</b>	<b>POWER WIRING ERROR</b>	<b>GDO WON'T RUN BECAUSE</b>
6B	FIRE DOOR SHTDN	GDO WON'T RUN BECAUSE OF LOSS OF POWER
6C	NO RUN > DOWN LIM	GDO WON'T CLOSE BECAUSE ITS ALREADY AT THE DOWN LIMIT
6D	NO RUN > UP LIMIT	GDO WON'T OPEN BECAUSE ITS ALREADY AT THE UP LIMIT
6E	NO RUN > MID STOP	GDO WON'T RUN BECAUSE ITS AT OR ABOVE THE MID-STOP LIMIT & CAN'T RUN UP & A REVERSING INPUT IS PREVENTING IT FROM CLOSING
6F	EXP MODULE FAIL	GDO WON'T RUN BECAUSE AN EXPANSION MODULE FAILURE IS PREVENTING IT



# Appendix C (cont')

## Error Codes Displays (continued)

Condition Code	DISPLAY	Condition Code Description
70	<b>BOARD FAILURE 70</b>	<b>CONTROL BOARD FAILURE 70, CONTACT FACTORY TECHNICAL SERVICE DEPT.</b>
71	BOARD FAILURE 71	CONTROL BOARD FAILURE 71, CONTACT FACTORY TECHNICAL SERVICE DEPT.
74	BOARD FAILURE 74	CONTROL BOARD FAILURE 74, CONTACT FACTORY TECHNICAL SERVICE DEPT.
75	BOARD FAILURE 75	CONTROL BOARD FAILURE 75, CONTACT FACTORY TECHNICAL SERVICE DEPT.
76	BOARD FAILURE 76	CONTROL BOARD FAILURE 76, CONTACT FACTORY TECHNICAL SERVICE DEPT.
77	BOARD FAILURE 77	CONTROL BOARD FAILURE 77, CONTACT FACTORY TECHNICAL SERVICE DEPT.
80	<b>BOARD FAILURE 80</b>	<b>CONTROL BOARD FAILURE 80, CONTACT FACTORY TECHNICAL SERVICE DEPT.</b>
81	BOARD FAILURE 81	CONTROL BOARD FAILURE 81, CONTACT FACTORY TECHNICAL SERVICE DEPT.
82	BOARD FAILURE 82	CONTROL BOARD FAILURE 82, CONTACT FACTORY TECHNICAL SERVICE DEPT.
83	BOARD FAILURE 83	CONTROL BOARD FAILURE 83, CONTACT FACTORY TECHNICAL SERVICE DEPT.
84	BOARD FAILURE 84	CONTROL BOARD FAILURE 84, CONTACT FACTORY TECHNICAL SERVICE DEPT.
85	EXP PORT PROBLEM	EXPANSION PORT IS SHORT CIRCUITED, TRY DISCONNECTING EXPANSION MODULES OR CONTACT TECHNICAL SERVICE DEPT.
86	BOARD FAILURE 86	CONTROL BOARD FAILURE 86, DISCONNECT EXPANSION MODULES. IF NO CHANGE, CONTACT ++TECHNICAL SERVICE DEPT.
87	IEM FAILURE	RESERVED--NOT CURRENTLY USED
88	TCM FAILURE	TIMER CLOSE MODULE (TCM) HAS FAILED
89	FDM FAILURE	FIRE DOOR MODULE (FDM) HAS FAILED
8A	<b>AOM FAILURE</b>	<b>AUXILIARY OUTPUT MODULE (AOM) HAS FAILED</b>
8B	SPARE MOD FAILURE	RESERVED--NOT CURRENTLY USED
8C	LOW SYSTEM VOLTS	POWER SUPPLY LINE VOLTAGE LOW
8D	HI SYSTEM VOLTS	POWER SUPPLY LINE VOLTAGE HIGH
8E	REV INTERRUPTED	GDO LOST POWER OR ENCOUNTERED ANOTHER PROBLEM DURING THE REVERSAL PROCESS, REVERSAL IS COMPLETING NOW
8F	LIMIT MOD. FAIL	GDO WON'T RUN, LIMIT MODULE HAS FAILED
90	<b>DIAGNOSTIC MODE</b>	<b>GDO IS IN DIAGNOSTIC MODE, NORMAL FUNCTIONS ARE NOT ALLOWED</b>
A0	OPEN BTN BAD > PU	OPEN & CLOSE BUTTONS WON'T WORK, THE OPEN BUTTON WAS ACTIVE WHEN THE GDO WAS POWERED-UP
A1	CLOSE BTN BAD > PU	OPEN & CLOSE BUTTONS WON'T WORK, THE CLOSE BUTTON WAS ACTIVE WHEN THE GDO WAS POWERED-UP
A2	ONE BTN BAD > PU	1 BUTTON WON'T WORK, THE 1 BUTTON WAS ACTIVE WHEN THE GDO WAS POWERED-UP
A3	RADIO BAD > PWR UP	RADIO INPUT WON'T WORK, THE RADIO INPUT WAS ACTIVE WHEN THE GDO WAS POWERED-UP
A4	AUX OPEN BAD > PU	AUXILIARY OPEN INPUT WON'T WORK, THE AUXILIARY OPEN INPUT WAS ACTIVE WHEN THE GDO WAS POWERED-UP
A5	OPEN KEY BAD > PU	KEYPAD OPEN & CLOSE KEYS WON'T WORK, THE OPEN KEY WAS ACTIVE WHEN THE GDO WAS POWERED-UP
A6	CLOSE KEY BAD > PU	KEYPAD OPEN & CLOSE KEYS WON'T WORK, THE CLOSE KEY WAS ACTIVE WHEN THE GDO WAS POWERED-UP
A7	MULT KEYS BAD > PU	1 OR MORE KEYPAD CALIBRATION KEYS WON'T WORK, 1 OR MORE WERE ACTIVE WHEN THE GDO WAS POWERED-UP
AA	TCM BAD > POWER UP	RESERVED--NOT CURRENTLY USED
AB	FDM BAD > POWER UP	RESERVED--NOT CURRENTLY USED
B0	<b>OPENING &gt; XMTR #</b>	<b>OPENING FROM TRANSMITTER # ___</b>
B1	CLOSING > XMTR #	CLOSING FROM TRANSMITTER # ___
B2	HALT > XMTR #	HALT FROM TRANSMITTER # ___
B3	NO XMTR > CC	NO CONTROL FROM TRANSMITTER, CONSTANT CONTACT EMPLOYED AT LOCAL CONTROL

**The Genuine. The Original.**



**RHX®**

**Commercial Operator Limited Warranty**

Overhead Door Corporation ("Seller") warrants to the original purchaser of the model RHX® FireKing® commercial door operator ("Product"), subject to all of the terms and conditions hereof, that the Product and all components thereof will be free from defects in materials and workmanship under normal use for the following period(s), measured from the date of installation:

- Two (2) years

Seller's obligation under this warranty is specifically limited to repairing or replacing, at its option, any part which is determined by Seller to be defective during the applicable warranty period. Any labor charges are excluded and will be the responsibility of the purchaser.

This warranty is made to the original purchaser of the Product only, and is not transferable or assignable. This warranty does not apply to any unauthorized alteration or repair of the Product, or to any Product or component which has been damaged or deteriorated due to misuse, neglect, accident, operation outside published ratings, failure to provide necessary maintenance, normal wear and tear, or acts of God or any other cause beyond the reasonable control of Seller.

**THIS WARRANTY IS EXCLUSIVE AND IN LIEU OF ANY OTHER WARRANTIES, EITHER EXPRESSED OR IMPLIED, INCLUDING BUT NOT LIMITED TO ANY IMPLIED WARRANTY OF MERCHANTABILITY OR FITNESS FOR A PARTICULAR PURPOSE.**

**IN NO EVENT SHALL SELLER BE RESPONSIBLE FOR, OR LIABLE TO ANYONE FOR, SPECIAL, INDIRECT, COLLATERAL, PUNITIVE, INCIDENTAL OR CONSEQUENTIAL DAMAGES, even if Seller has been advised of the possibility of such damages. Such excluded damages include, but are not limited to, loss of goodwill, loss of profits, loss of use, cost of any substitute product, interruption of business, or other similar indirect financial loss.**

Claims under this warranty must be made promptly after discovery, within the applicable warranty period, and in writing to the Seller or to the authorized distributor or installer whose name and address appear below. The purchaser must allow Seller a reasonable opportunity to inspect any Product claimed to be defective prior to removal or any alteration of its condition. Proof of the purchase and/or installation date, and identification as the original purchaser, may be required.

ORIGINAL PURCHASER: \_\_\_\_\_

INSTALLATION ADDRESS: \_\_\_\_\_

SELLER: \_\_\_\_\_

SELLER'S ADDRESS: \_\_\_\_\_

FACTORY ORDER #: \_\_\_\_\_

DATE OF INSTALLATION: \_\_\_\_\_

SIGNATURE OF SELLER: \_\_\_\_\_

THIS PAGE LEFT BLANK

**The Genuine. The Original.**



1 DOOR DRIVE  
MT. HOPE, OHIO 44660  
[www.overheaddoor.com](http://www.overheaddoor.com)

CODE 128 BARCODE  
LOCATION

112166.502351