

MODEL	STANDARD MAX. VALUES	
	WIDTH	HEIGHT
652	20'	9'

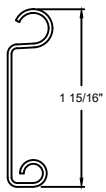

F158 SLAT SECTION

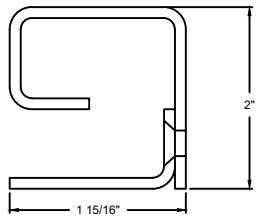

GUIDE DETAIL

**OPTIONS**

OPENING WIDTH

OPENING HEIGHT

LOCK OPTIONS

- CREMONE CYLINDER
- SLIDE BOLTS
- LOCK MORTISE
- LOCK T HANDLE
- THUMB OPTION

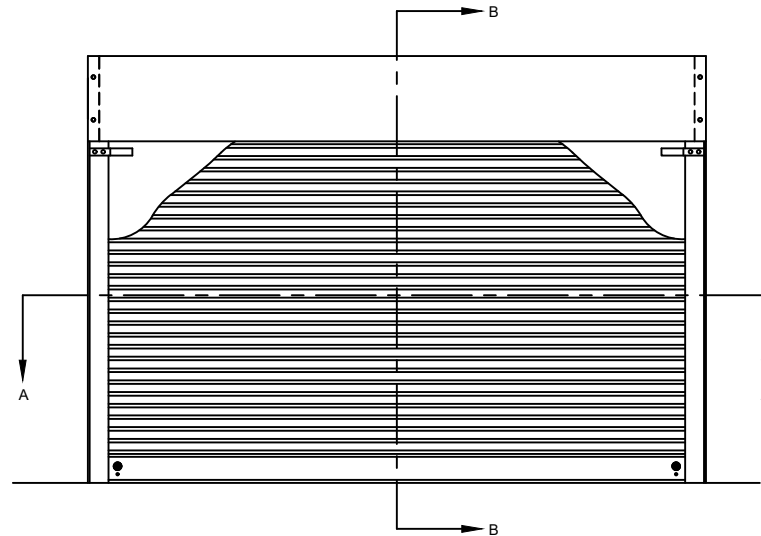

ELEVATION

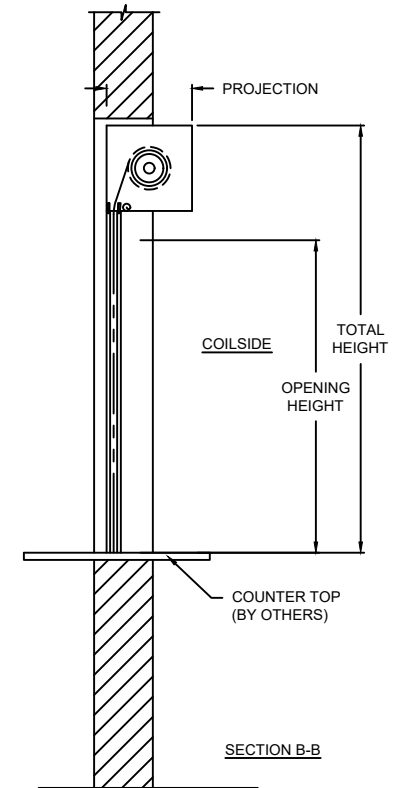

SECTION B-B

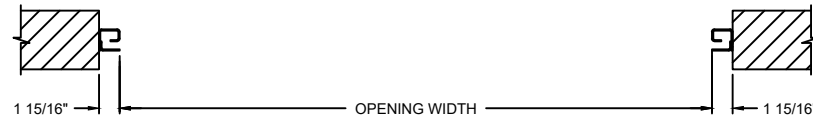

COILSIDE

SECTION A-A

PROJECTION	
MIN.	MAX.
9.5" X 9.5"	11.5" X 11.5"

COMPONENT	MATERIAL	OPERATION	NOTES:
HOOD	.050" THICK ALUMINUM	MANUAL PUSH UP	- WARRANTY: 24-MONTH LIMITED
CURTAIN	.040" THICK ALUMINUM		
GUIDES	STEEL		
FINISH	ALUMINUM, CLEAR ANODIZED		

# COUNTER DOORS

652 ROLLING COUNTER DOORS - BETWEEN JAMBS

DWG. NO.	DATE:	
SHEET	BY:	

MODEL	STANDARD MAX. VALUES	
	WIDTH	HEIGHT
652	20'	9'

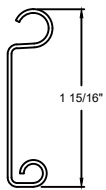

F158 SLAT SECTION

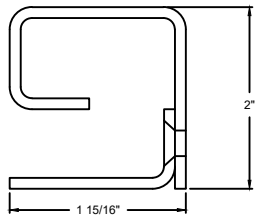

GUIDE DETAIL

**OPTIONS**

OPENING WIDTH

OPENING HEIGHT

LOCK OPTIONS

- CREMONE CYLINDER
- SLIDE BOLTS
- LOCK MORTISE
- LOCK T HANDLE
- THUMB OPTION

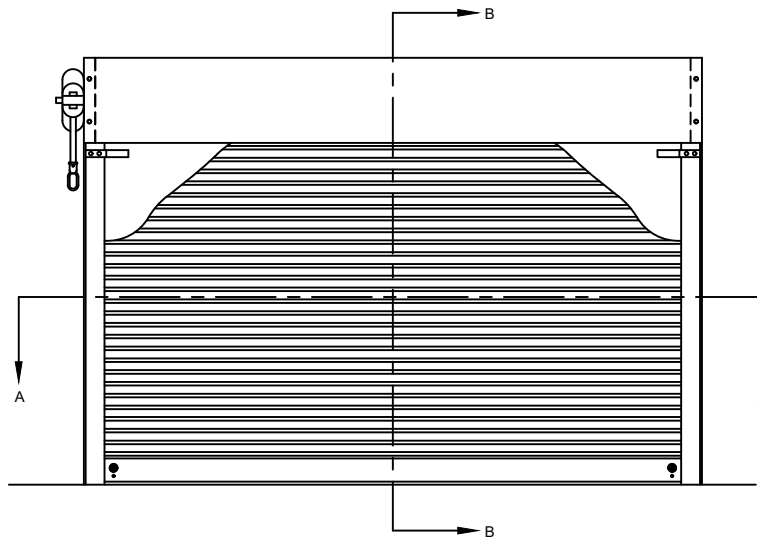

ELEVATION

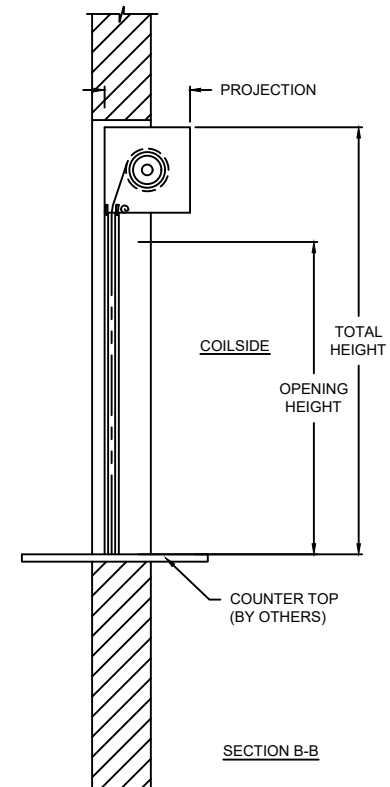

SECTION B-B

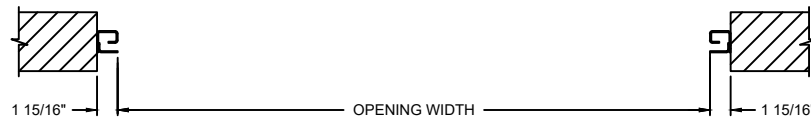

COILSIDE

SECTION A-A

PROJECTION	
MIN.	MAX.
9.5" X 9.5"	11.5" X 11.5"

COMPONENT	MATERIAL	OPERATION	NOTES:
HOOD	.050" THICK ALUMINUM	CRANK LH	- WARRANTY: 24-MONTH LIMITED
CURTAIN	.040" THICK ALUMINUM		
GUIDES	STEEL		
FINISH	ALUMINUM, CLEAR ANODIZED		

# COUNTER DOORS

652 ROLLING COUNTER DOORS - BETWEEN JAMBS

DWG. NO.	DATE:	
SHEET	BY:	

MODEL	STANDARD MAX. VALUES	
	WIDTH	HEIGHT
652	20'	9'

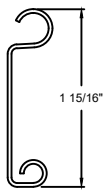

F158 SLAT SECTION

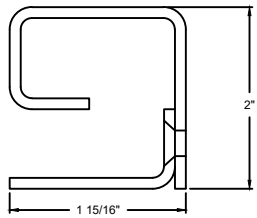

GUIDE DETAIL

**OPTIONS**

OPENING WIDTH

OPENING HEIGHT

LOCK OPTIONS

- CREMONE CYLINDER
- SLIDE BOLTS
- LOCK MORTISE
- LOCK T HANDLE
- THUMB OPTION

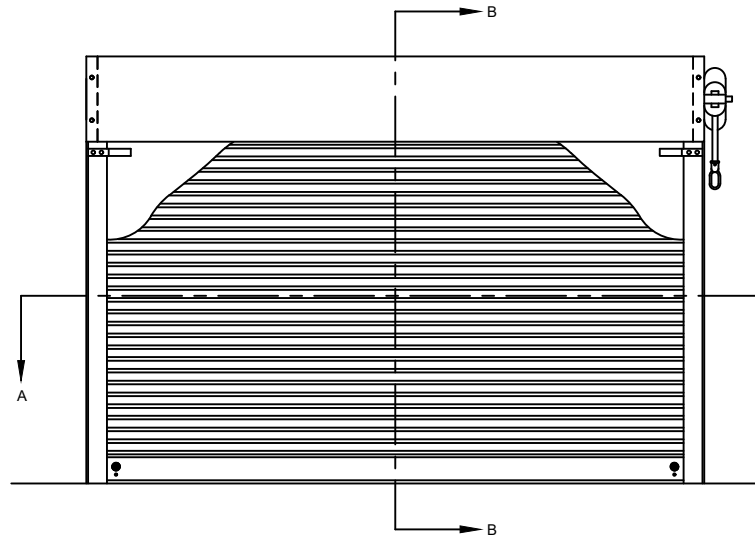

ELEVATION

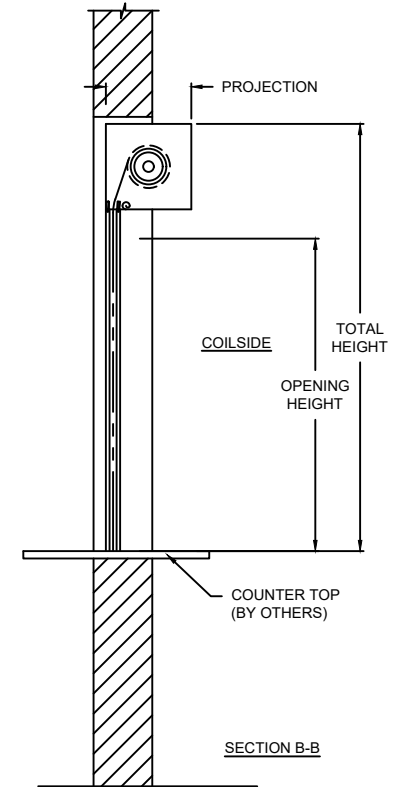

SECTION B-B



OPENING WIDTH

COILSIDE

SECTION A-A

PROJECTION	
MIN.	MAX.
9.5" X 9.5"	11.5" X 11.5"

COMPONENT	MATERIAL	OPERATION	NOTES:
HOOD	.050" THICK ALUMINUM	CRANK RH	- WARRANTY: 24-MONTH LIMITED
CURTAIN	.040" THICK ALUMINUM		
GUIDES	STEEL		
FINISH	ALUMINUM, CLEAR ANODIZED		

# COUNTER DOORS

652 ROLLING COUNTER DOORS- BETWEEN JAMBS

DWG. NO.	DATE:	<b>The Genuine. The Original.</b> 
SHEET	BY:	

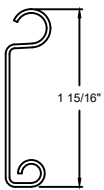

F158 SLAT SECTION

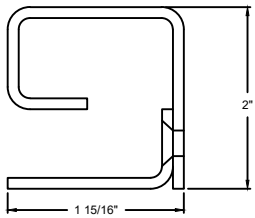

GUIDE DETAIL

**OPTIONS**

OPENING WIDTH

OPENING HEIGHT

LOCK OPTIONS

- CREMONE CYLINDER
- SLIDE BOLTS
- LOCK MORTISE
- LOCK T HANDLE
- THUMB OPTION

MODEL	STANDARD MAX. VALUES	
	WIDTH	HEIGHT
652	20'	9'

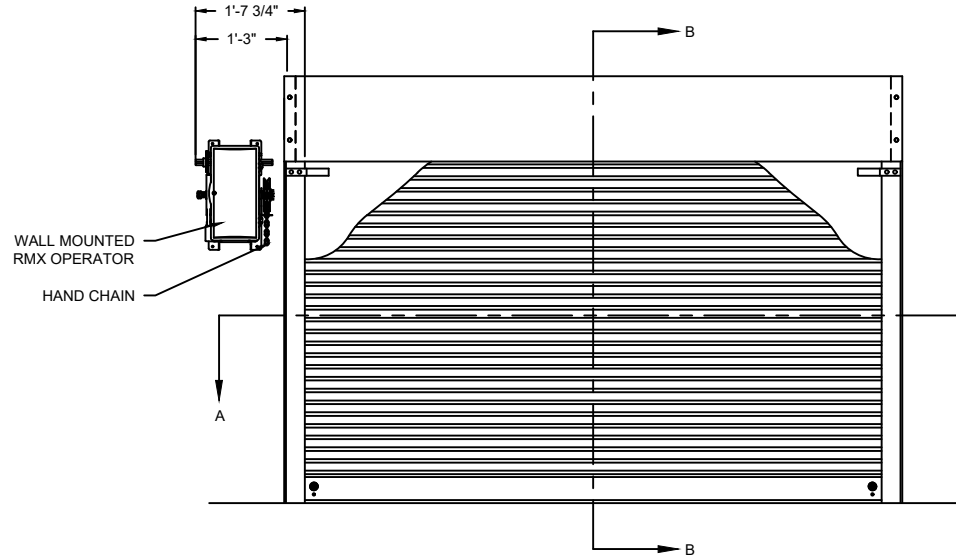

ELEVATION

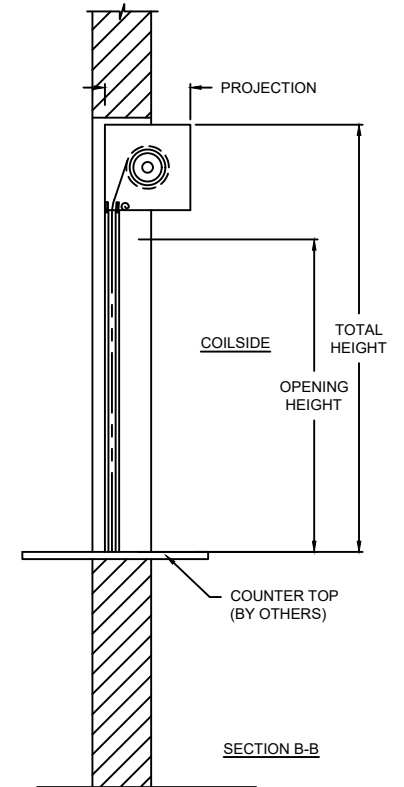

SECTION B-B

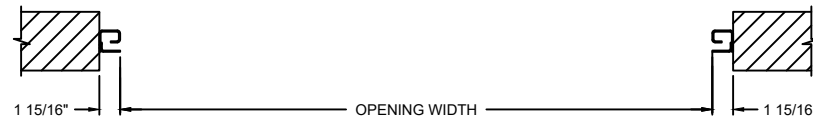

COILSIDE

SECTION A-A

PROJECTION	
MIN.	MAX.
9.5" X 9.5"	11.5" X 11.5"

COMPONENT	MATERIAL	OPERATION	NOTES:
HOOD	.050" THICK ALUMINUM	RMX OPERATOR LH	- WARRANTY: 24-MONTH LIMITED
CURTAIN	.040" THICK ALUMINUM		
GUIDES	STEEL		
FINISH	ALUMINUM, CLEAR ANODIZED		

# COUNTER DOORS

652 ROLLING COUNTER DOORS - BETWEEN JAMBS

DWG. NO.	DATE:	<b>The Genuine. The Original.</b> <b>OVERHEAD DOOR</b>
SHEET	BY:	

MODEL	STANDARD MAX. VALUES	
	WIDTH	HEIGHT
652	20'	9'

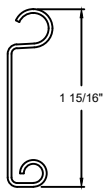

F158 SLAT SECTION

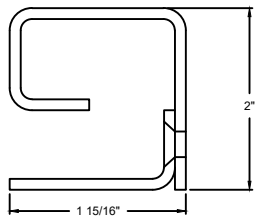

GUIDE DETAIL

**OPTIONS**

OPENING WIDTH	
OPENING HEIGHT	
LOCK OPTIONS	<input type="checkbox"/> CREMONE CYLINDER <input type="checkbox"/> SLIDE BOLTS <input type="checkbox"/> LOCK MORTISE <input type="checkbox"/> LOCK T HANDLE <input type="checkbox"/> THUMB OPTION

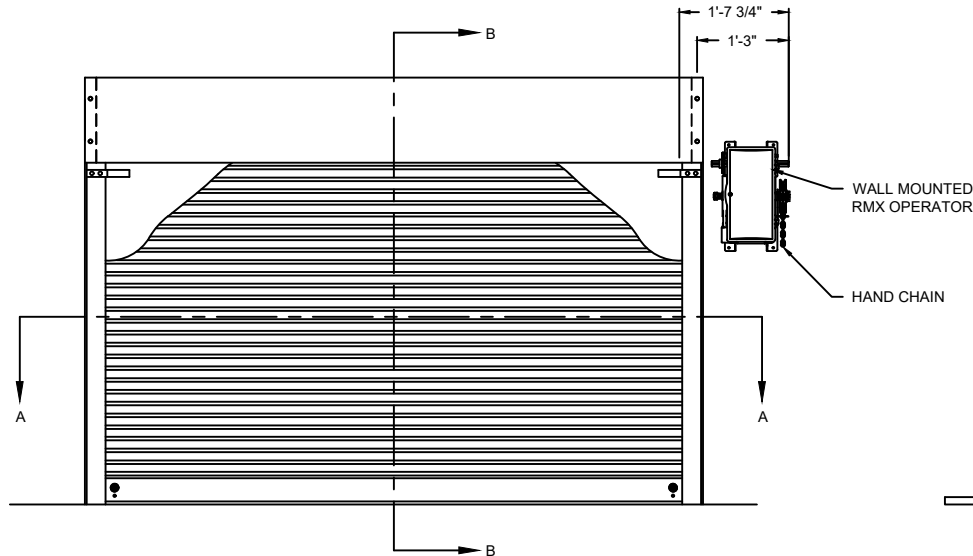

ELEVATION

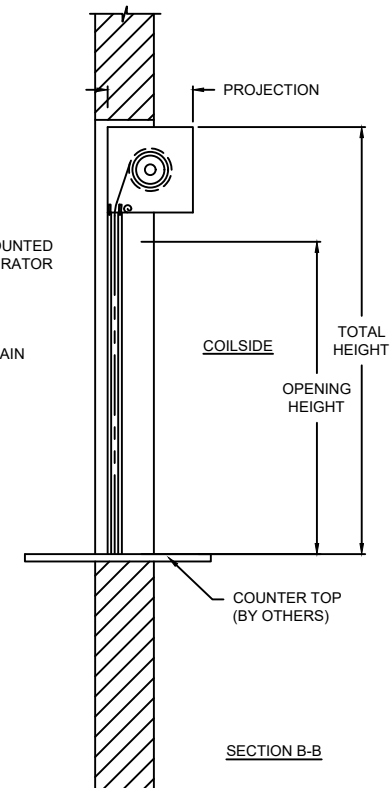

SECTION B-B

PROJECTION	
MIN.	MAX.
9.5" X 9.5"	11.5" X 11.5"

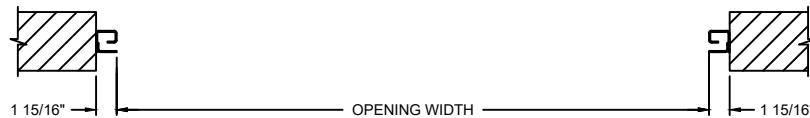

COILSIDE

SECTION A-A

# COUNTER DOORS

652 ROLLING COUNTER DOORS - BETWEEN JAMBS

DWG. NO.	DATE:	
SHEET	BY:	

COMPONENT	MATERIAL	OPERATION	NOTES:
HOOD	.050" THICK ALUMINUM	RMX OPERATOR RH	- WARRANTY: 24-MONTH LIMITED
CURTAIN	.040" THICK ALUMINUM		
GUIDES	STEEL		
FINISH	ALUMINUM, CLEAR ANODIZED		