

MODEL	STANDARD MAX. VALUES	
	WIDTH	HEIGHT
651	20'	9'

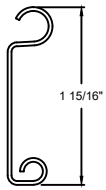

F158 SLAT SECTION

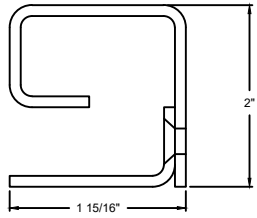

GUIDE DETAIL

OPTIONS

OPENING WIDTH	
OPENING HEIGHT	
LOCK OPTIONS	<input type="checkbox"/> CREMONE CYLINDER <input type="checkbox"/> SLIDE BOLTS <input type="checkbox"/> LOCK MORTISE <input type="checkbox"/> LOCK T HANDLE <input type="checkbox"/> THUMB OPTION

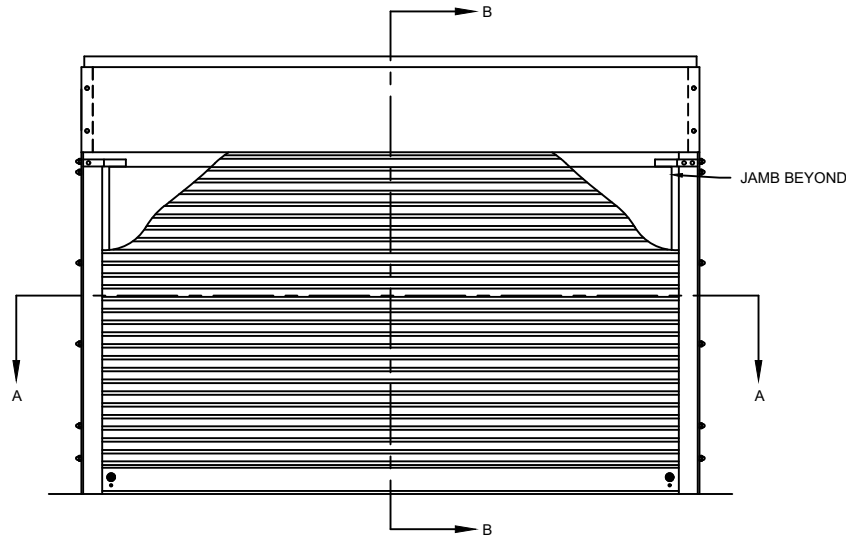

ELEVATION

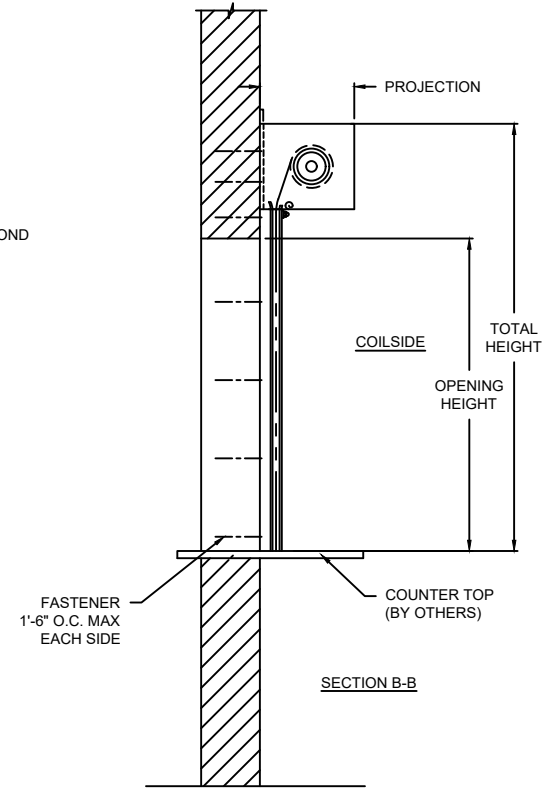

SECTION B-B



SECTION A-A

SETBACK ON STEEL GUIDES MOUNTED TO STEEL JAMBS WILL BE 1/4" ALL OTHER MOUNTING SURFACES WILL BE 15/16" AS SHOWN

COILSIDE

SECTION A-A

PROJECTION	
MIN.	MAX.
9.5" X 9.5"	11.5" X 11.5"

COUNTER DOORS

651 ROLLING COUNTER DOORS - FACE MOUNT

DWG. NO.	DATE:	
SHEET	BY:	

COMPONENT	MATERIAL	OPERATION	NOTES:
HOOD	24 GA. STAINLESS STEEL	MANUAL PUSH UP	- WARRANTY: 24-MONTH LIMITED
CURTAIN	22 GA. STAINLESS STEEL		
GUIDES	STEEL		
FINISH	NO. 4 STAINLESS STEEL		

MODEL	STANDARD MAX. VALUES	
	WIDTH	HEIGHT
651	20'	9'

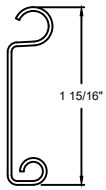

F158 SLAT SECTION

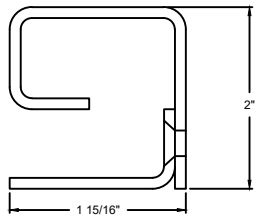

GUIDE DETAIL

OPTIONS

OPENING WIDTH

OPENING HEIGHT

LOCK OPTIONS

- CREMONE CYLINDER
- SLIDE BOLTS
- LOCK MORTISE
- LOCK T HANDLE
- THUMB OPTION

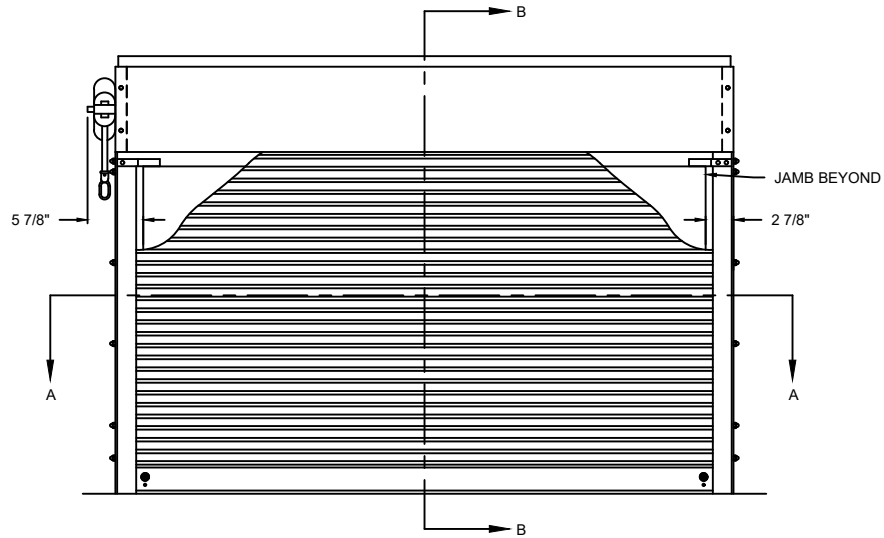

ELEVATION

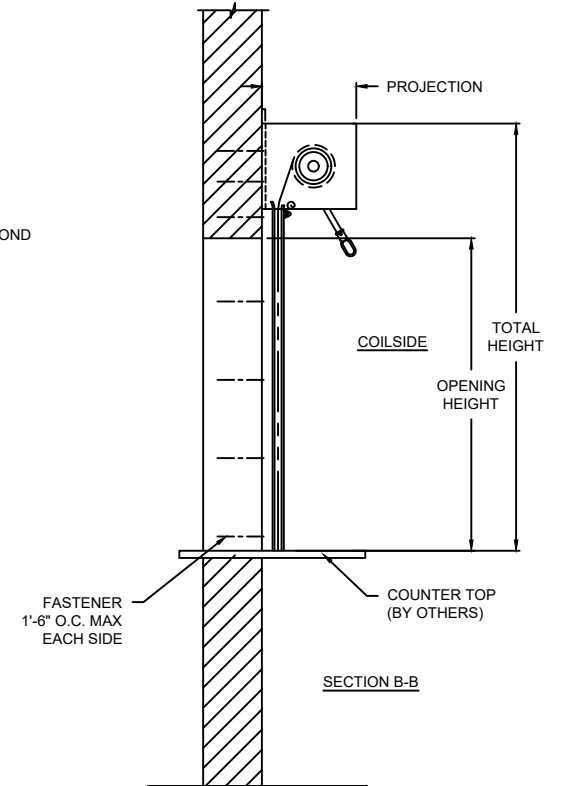

SECTION B-B



SECTION A-A

SETBACK ON STEEL GUIDES MOUNTED TO STEEL JAMBS WILL BE 1/4" ALL OTHER MOUNTING SURFACES WILL BE 15/16" AS SHOWN

COILSIDE

SECTION A-A

PROJECTION	
MIN.	MAX.
9.5" X 9.5"	11.5" X 11.5"

COUNTER DOORS

651 ROLLING COUNTER DOORS - FACE MOUNT

DWG. NO.	DATE:	The Genuine. The Original.
SHEET	BY:	

COMPONENT	MATERIAL	OPERATION	NOTES:
HOOD	24 GA. STAINLESS STEEL	CRANK LH	- WARRANTY: 24-MONTH LIMITED
CURTAIN	22 GA. STAINLESS STEEL		
GUIDES	STEEL		
FINISH	NO. 4 STAINLESS STEEL		

MODEL	STANDARD MAX. VALUES	
	WIDTH	HEIGHT
651	20'	9'

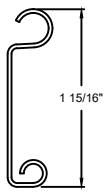

F158 SLAT SECTION

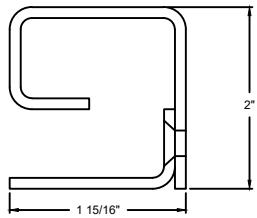

GUIDE DETAIL

OPTIONS

OPENING WIDTH

OPENING HEIGHT

LOCK OPTIONS

- CREMONE CYLINDER
- SLIDE BOLTS
- LOCK MORTISE
- LOCK T HANDLE
- THUMB OPTION

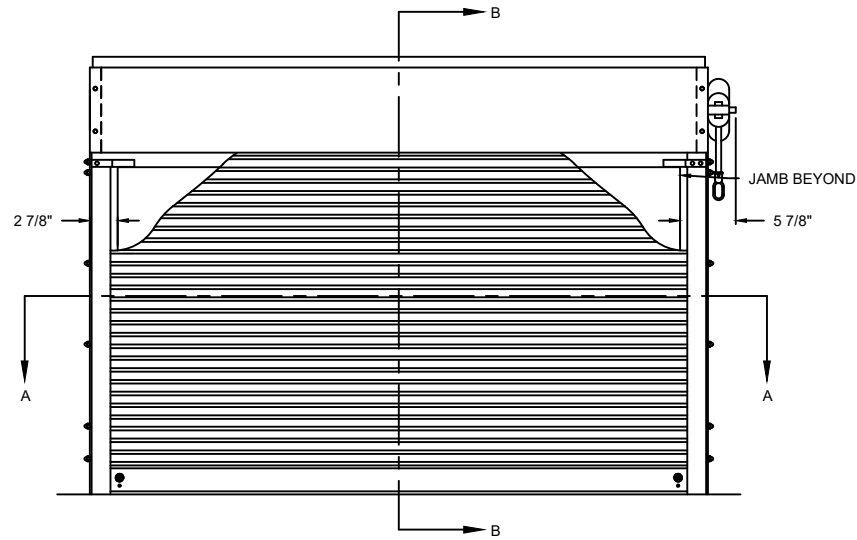

ELEVATION

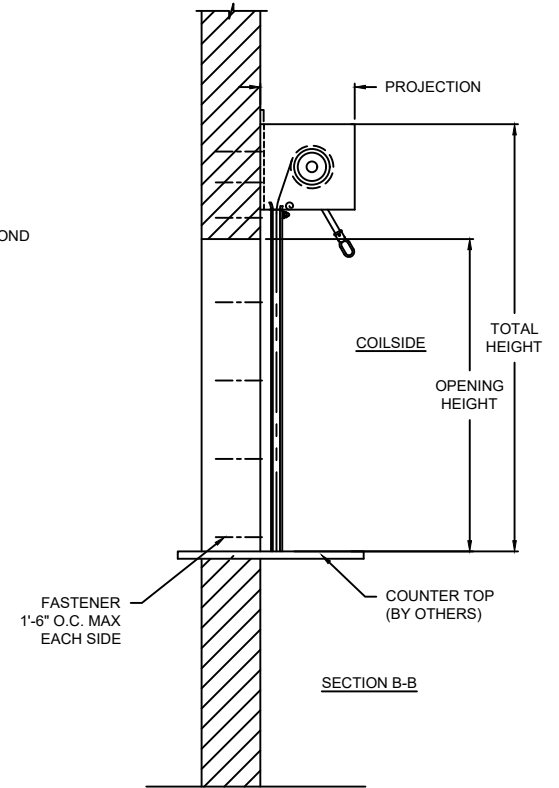

SECTION B-B



COILSIDE

SECTION A-A

SETBACK ON STEEL GUIDES MOUNTED TO STEEL JAMBS WILL BE 1/4" ALL OTHER MOUNTING SURFACES WILL BE 15/16" AS SHOWN

PROJECTION	
MIN.	MAX.
9.5" X 9.5"	11.5" X 11.5"

COUNTER DOORS

651 ROLLING COUNTER DOORS- FACE MOUNT

DWG. NO.	DATE:	The Genuine. The Original. OVERHEAD DOOR
SHEET	BY:	

COMPONENT	MATERIAL	OPERATION	NOTES:
HOOD	24 GA. STAINLESS STEEL	CRANK RH	- WARRANTY: 24-MONTH LIMITED
CURTAIN	22 GA. STAINLESS STEEL		
GUIDES	STEEL		
FINISH	NO. 4 STAINLESS STEEL		

MODEL	STANDARD MAX. VALUES	
	WIDTH	HEIGHT
651	20'	9'

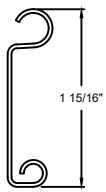

F158 SLAT SECTION

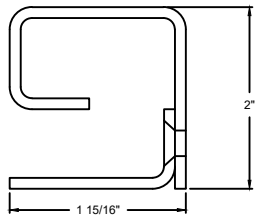

GUIDE DETAIL

OPTIONS

OPENING WIDTH

OPENING HEIGHT

LOCK OPTIONS

- CREMONE CYLINDER
- SLIDE BOLTS
- LOCK MORTISE
- LOCK T HANDLE
- THUMB OPTION

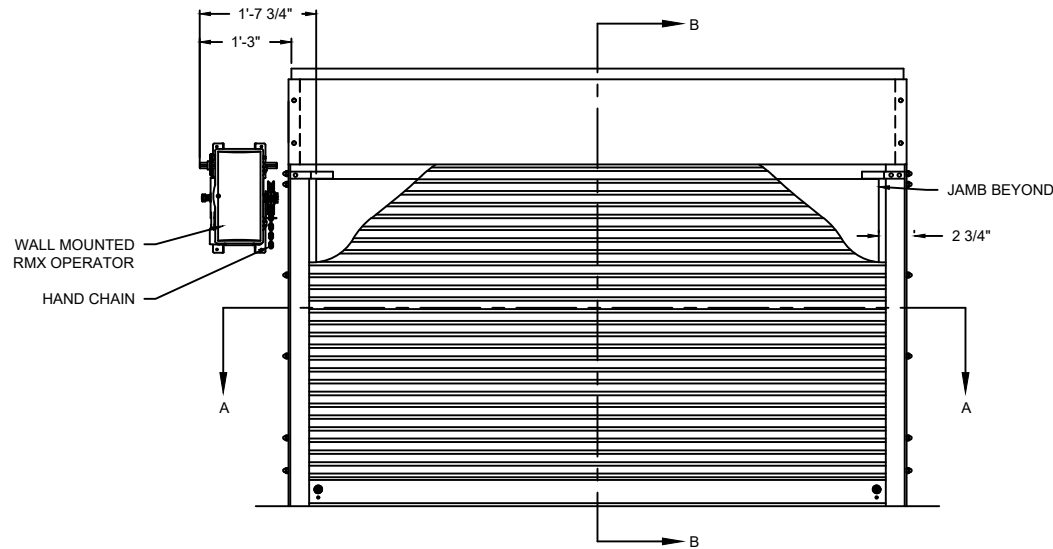

ELEVATION

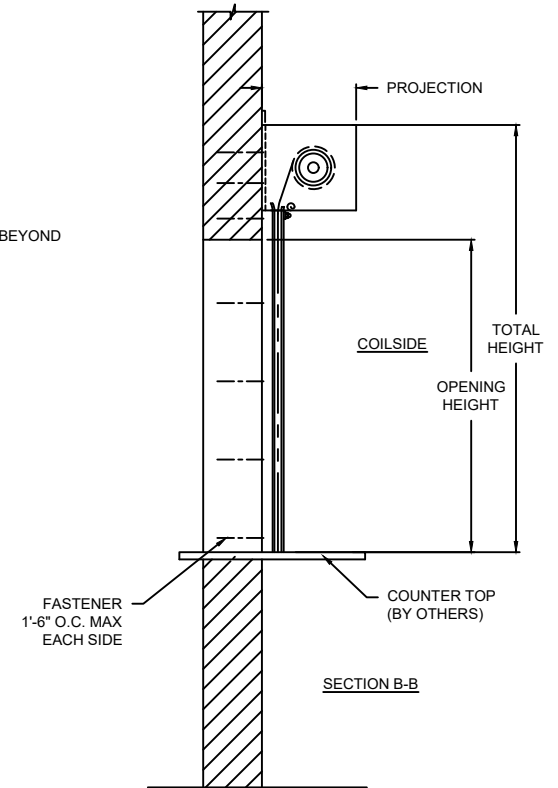

SECTION B-B



SECTION A-A

SETBACK ON STEEL GUIDES MOUNTED TO STEEL JAMBS WILL BE 1/4" ALL OTHER MOUNTING SURFACES WILL BE 15/16" AS SHOWN

COILSIDE

PROJECTION	
MIN.	MAX.
9.5" X 9.5"	11.5" X 11.5"

COUNTER DOORS

651 ROLLING COUNTER DOORS - FACE MOUNT

DWG. NO.	DATE:	The Genuine. The Original.
SHEET	BY:	

COMPONENT	MATERIAL	OPERATION	NOTES:
HOOD	24 GA. STAINLESS STEEL	RMX OPERATOR LH	- WARRANTY: 24-MONTH LIMITED
CURTAIN	22 GA. STAINLESS STEEL		
GUIDES	STEEL		
FINISH	NO. 4 STAINLESS STEEL		

MODEL	STANDARD MAX. VALUES	
	WIDTH	HEIGHT
651	20'	9'

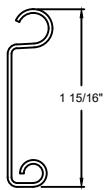

F158 SLAT SECTION

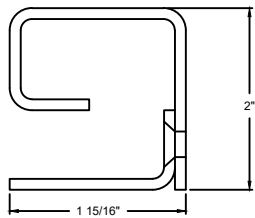

GUIDE DETAIL

OPTIONS

OPENING WIDTH	
OPENING HEIGHT	
LOCK OPTIONS	<input type="checkbox"/> CREMONE CYLINDER <input type="checkbox"/> SLIDE BOLTS <input type="checkbox"/> LOCK MORTISE <input type="checkbox"/> LOCK T HANDLE <input type="checkbox"/> THUMB OPTION

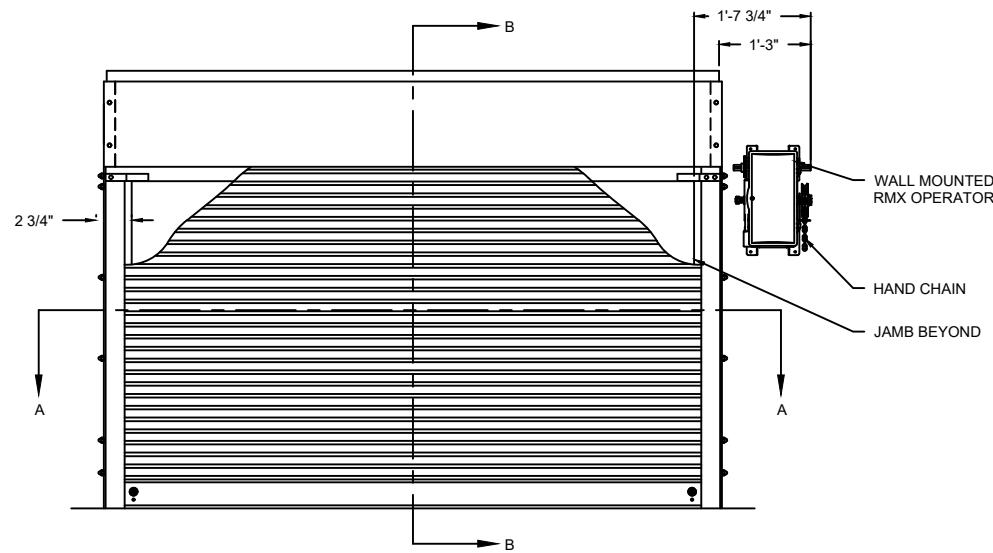

ELEVATION

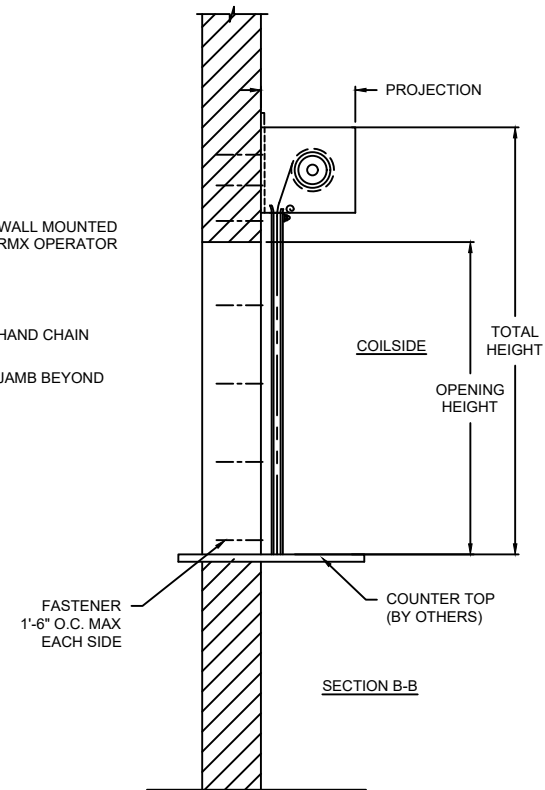

SECTION B-B

PROJECTION	
MIN.	MAX.
9.5" X 9.5"	11.5" X 11.5"



COILSIDE

SECTION A-A

SETBACK ON STEEL GUIDES MOUNTED TO STEEL JAMBS WILL BE 1/4" ALL OTHER MOUNTING SURFACES WILL BE 15/16" AS SHOWN

COUNTER DOORS

651 ROLLING COUNTER DOORS - FACE MOUNT

DWG. NO.	DATE:	
SHEET	BY:	

COMPONENT	MATERIAL	OPERATION	NOTES:
HOOD	24 GA. STAINLESS STEEL	RMX OPERATOR RH	- WARRANTY: 24-MONTH LIMITED
CURTAIN	22 GA. STAINLESS STEEL		
GUIDES	STEEL		
FINISH	NO. 4 STAINLESS STEEL		